

Panasonic

BUSINESS

Supermarket Showcase
General Catalog



Supermarket showcase

EXC

S E R I E S

Environment & Convenience



Panasonic Commercial Equipment Systems Asia Pacific

Contents

Product Features	2-3
Multi-deck showcase	4-9
   	
CPW-EXC FPW-EXC CPW-EXC FEW-EXC	
Semi-multi-deck showcase	10-14
  	
CPS-EXC CPS-EXC FPS-EXC	
Freezer showcase	15
	
CZR-EXC	
Reach-in showcase	16-17
	
FLD-EXC	
Island freezer showcase	18-24 34-35
    	
TVQ-EXC TVQ-EXC TVQ-EXC CZM-EXC CZM-EXC	
Serve over showcase	26-31
   	
FAM-BD FAM-BD FAM-IE FAM-IE	
Island showcase	25 32-33
  	
CSM-EXC CSM-EXC TEM-EXC	
Backyard equipment	36-37
   	
CC-CV series CC-CM series CC-CD series CC-CTL series	
Technical data section	38-41

Supermarket / Hypermarket

We contribute to efficient shop management and maintaining the freshness of goods with our showcase and shop monitoring technologies.



Convenience Store / Mini-supermarket

High efficiency showcases suitable for various types and locations of shops.



Kitchen

Reliable kitchen equipment with environmentally friendly and smart solutions for professionals.



Recommended color variation (Here's sampling)

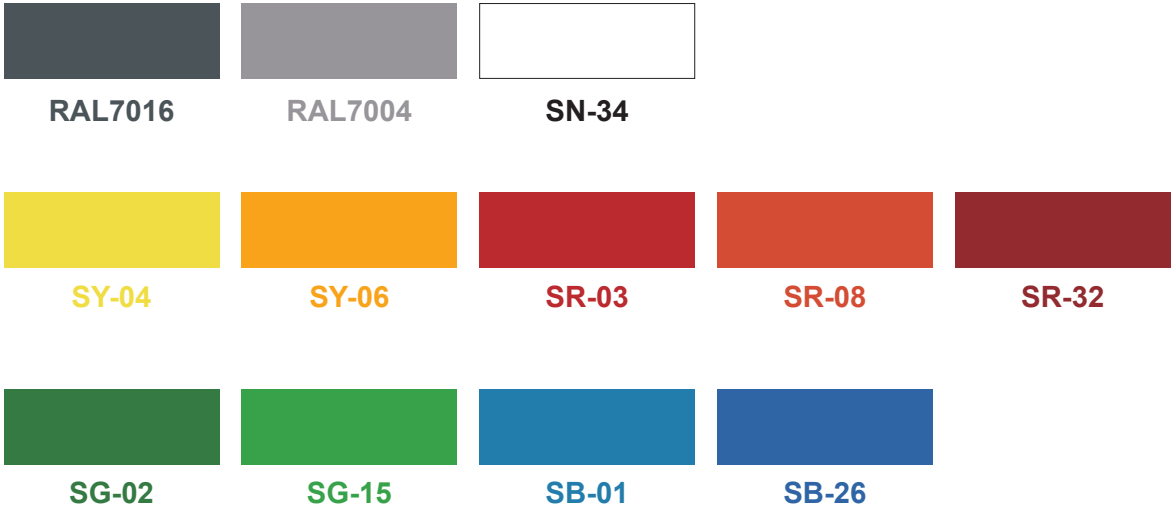

*Other colors are available.

Product Features

A design approach

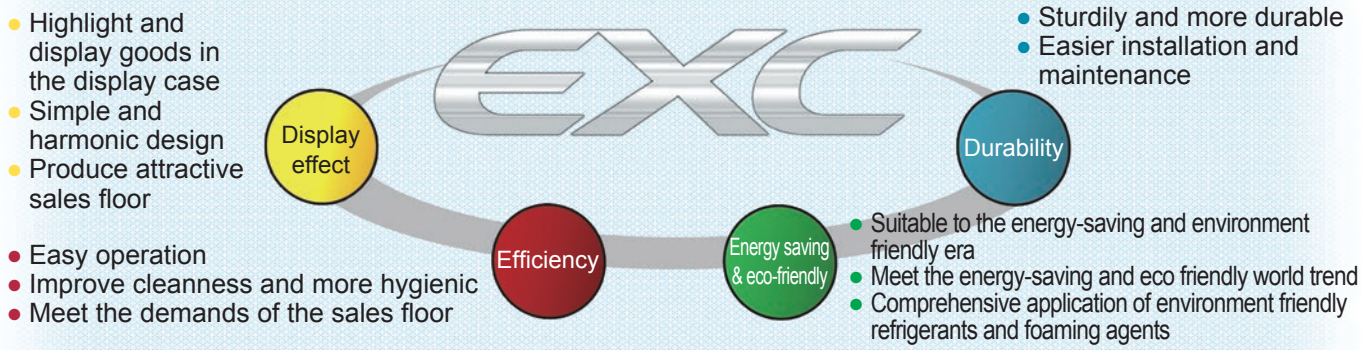

Attractive high-quality harmonic shape design

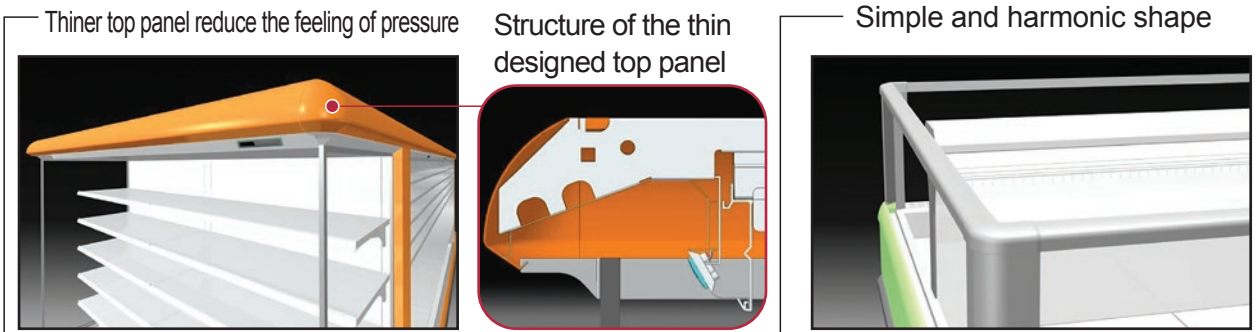

Harmonic carved design Softness and smoother silhouette are emphasized Price tags on the lowest level are positioned where customers can easily see them

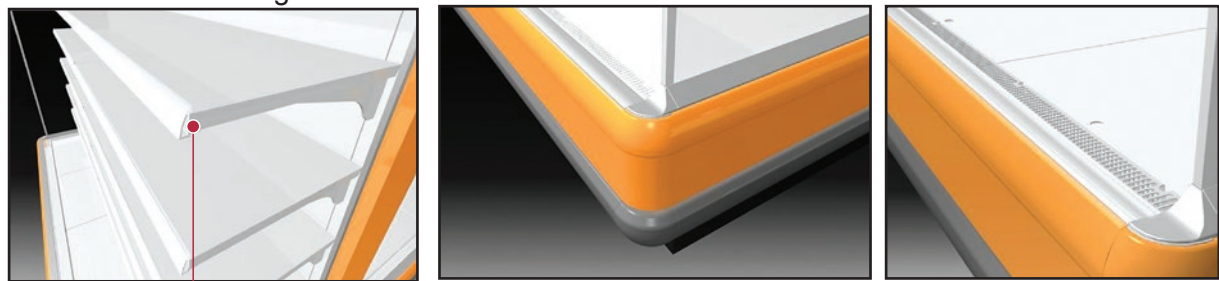

A beautiful, joint-less surface

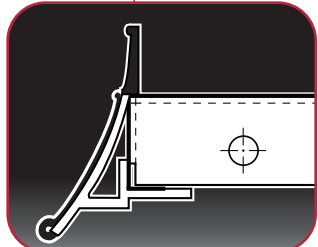

The shelves equipped with waterproof price-tag covers

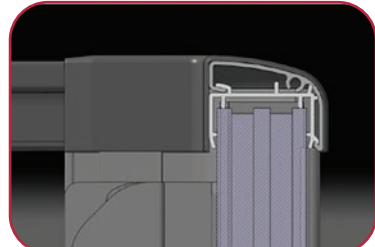

Joints inside handrail

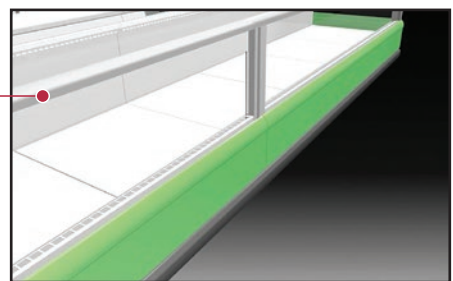

A genuine, high-efficiency, double air curtain

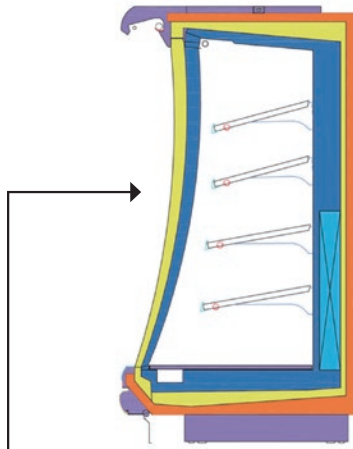

Diagram of the genuine double air curtain
The blue area is where the interior air curtain circulates,
The yellow area is where the exterior air curtain circulates.

The double air curtain saves 10% more energy saving than a single-layer air curtain.

Evaporator with adjustable fins

A sensible, high-efficiency evaporator should build up frost evenly and should cool for a long time while defrosting for a short time and infrequently. Evaporators with a fixed distance between the fins do not defrost evenly, and the side exposed to the air builds up much more frost than the rest. As the frost layer increases, the amount of air provided decreases, and the temperature rises sharply. The evaporator for the EXC system, however, has an adjustable design. The distance between the fins that are exposed to the air increases, while the distance between those on the lee side stays the same. When frost builds up unevenly, this difference is increased further to reduce temperature fluctuations inside, thereby shortening the defrost time which has the substantial benefit of saving power.



A configuration designed to ergonomically suit Asian people

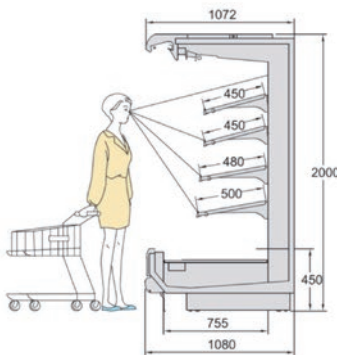

Illustration of an Asian woman with average height examining the products

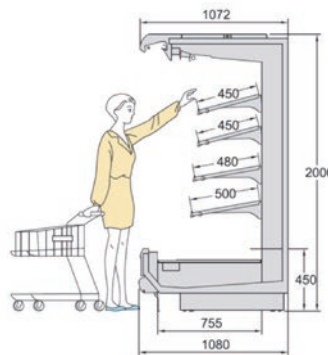

Illustration of an Asian woman with average height picking up a product from the top shelf

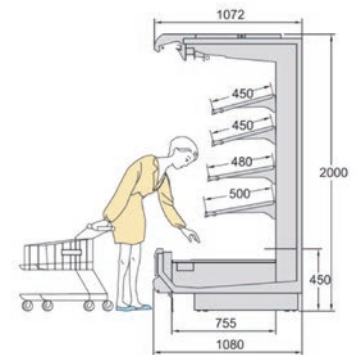

Illustration of an Asian woman with average height picking up a product from the bottom shelf

Making the products easy to see and reach is the fundamental design principle behind each dimension. Dimensions such as the height, the width, the handrail height, and the shelf width have all been optimized with a thorough consideration for the particulars of Asian ergonomics to better suit the Asian female shopper.

Comprehensive energy-saving solution



LED



ESM speed adjustable, energy-saving fan

According to the conditions of different retail sales floors, Panasonic provides customers with a comprehensive energy-saving solution, including energy-saving refrigeration systems design, optimized control-system configurations, advanced energy-saving equipment implementation, and guidance and instruction for economical operation.

EXC controller



- The digital-display micro controller has complete control over the operation of the refrigerated display.
- Integrated lighting control
- Single-switch start / stop refrigeration
- Equipped with a remote communication function and greater scalability
- Implements diverse energy-saving functions

Multi-deck showcase

Features and options for Multi-deck showcase

Features:

- All-metal exterior, soft lines, and a simple and rich texture
- Micro-computer digital-display temperature controller
- Energy-saving rectifier
- Energy-saving, double air curtain design
- Adjustable shelves
- Standardly equipped with price tag covers that are guaranteed to protect the tags and are easy for customers to view
- Refrigerant: R404A, and R407F
- Standardly LED lighting

Options:

- Mirror and curved mirror
- Covered support truss
- Guard for the return-air-vent shelf
- ESM speed-adjustable, energy-saving fan
- Additional glass shelf guards
- Anti-reflective shelves
- Aluminum-sheet night curtain
- External lighting
- Covered stepped truss
- Additional glass-panel handrail
- LED advertising display
- Installable glass door for the open-style refrigerated case
- Customizable exterior color
- Various side panels

- Aluminum-sheet night curtain
- LED advertising display
- Mirror and curved mirror
- External lighting
- Anti-reflective shelf
- Glass shelf guard
- Glass-panel handrail
- Guard for the return-air-vent shelf
- Covered support truss
- Covered stepped truss
- LED lighting
- Sealable display doors
- ESM speed adjustable, energy-saving fan

* Unless otherwise noted, the accessories showed in pictures are optional parts.



CPW-EXC084 (E)-L
CPW-EXC2084 (E)-L
CPW-EXC0884 (E)-L

Multi-deck showcase Dairy product & Daily <Fresh>

3°C to 7°C

• Remote type

- Operating temperature for LO-type,VO-type refrigerated outside corner : 5°C to 10°C.



Multi-deck showcase

Multi-deck showcase

Width 1080 mm; Height 2000 mm

Handrail height 350 mm

Product dimensions	Model	Length (mm)
	CPW-EXC063 (E)-L	1875
	CPW-EXC083 (E)-L	2500
	CPW-EXC023 (E)-L	3750
	CPW-EXC03U (E)-L	2368 (end case)

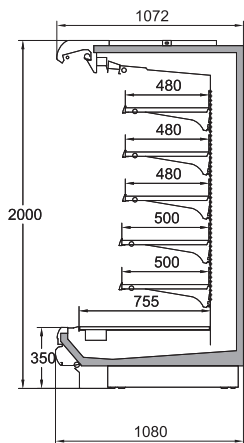

Width 1080 mm; Height 2000 mm

Handrail height 450 mm

Product dimensions	Model	Length (mm)
	CPW-EXC064 (E)-L	1875
	CPW-EXC084 (E)-L	2500
	CPW-EXC024 (E)-L	3750
	CPW-EXC04U (E)-L	2368 (end case)
	CPW-EXC04LO(E)-L	90° outer angle case
	CPW-EXC04LI(E)-L	90° inner angle case
	CPW-EXC04VO(E)-L	135° outer angle case
	CPW-EXC04VI(E)-L	135° inner angle case

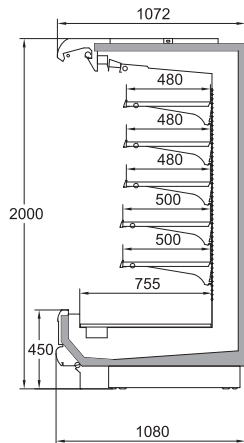

Width 1080 mm; Height 2000 mm

Handrail height 550 mm

Product dimensions	Model	Length (mm)
	CPW-EXC065 (E)-L	1875
	CPW-EXC085 (E)-L	2500
	CPW-EXC025 (E)-L	3750
	CPW-EXC05U (E)-L	2368 (end case)

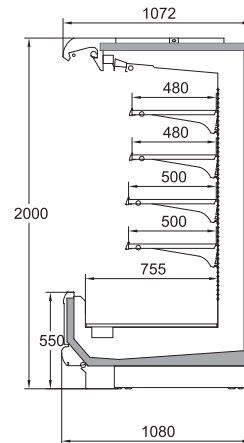

Width 1080 mm; Height 2200 mm

Handrail height 450 mm

Product dimensions	Model	Length (mm)
	CPW-EXC2064 (E)-L	1875
	CPW-EXC2084 (E)-L	2500
	CPW-EXC2024 (E)-L	3750
	CPW-EXC204U (E)-L	2368 (end case)

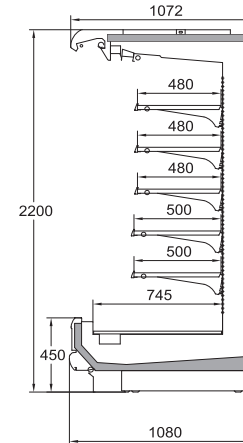

Width 880 mm; Height 2000 mm

Handrail height 350 mm

Product dimensions	Model	Length (mm)
	CPW-EXC0863 (E)-L	1875
	CPW-EXC0883 (E)-L	2500
	CPW-EXC0823 (E)-L	3750

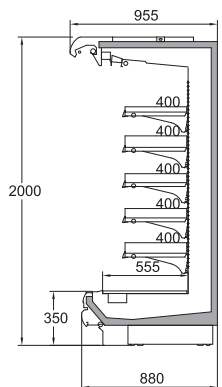

Width 880 mm; Height 2000 mm

Handrail height 450 mm

Product dimensions	Model	Length (mm)
	CPW-EXC0864 (E)-L	1875
	CPW-EXC0884 (E)-L	2500
	CPW-EXC0824 (E)-L	3750

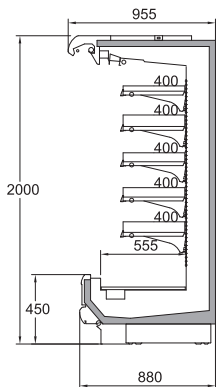

Multi-deck showcase



FPW-EXC084 (E)-L FPW-EXC2084 (E)-L Multi-deck showcase Fish & Meat

-2°C to 2°C • Remote type

• Operating temperature for the FPW-EXC083(E)/0883(E)/2084(E)series: 0°C to 4°C

Width 1080 mm; Height 2000 mm
Handrail height 350 mm

Model	Length (mm)
FPW-EXC063 (E)-L	1875
FPW-EXC083 (E)-L	2500
FPW-EXC023 (E)-L	3750
FPW-EXC03U (E)-L	2368 (end case)

Width 1080 mm; Height 2000 mm
Handrail height 450 mm

Model	Length (mm)
FPW-EXC064 (E)-L	1875
FPW-EXC084 (E)-L	2500
FPW-EXC024 (E)-L	3750
FPW-EXC04U (E)-L	2368 (end case)

Width 1080 mm; Height 2000 mm
Handrail height 550 mm

Model	Length (mm)
FPW-EXC065 (E)-L	1875
FPW-EXC085 (E)-L	2500
FPW-EXC025 (E)-L	3750
FPW-EXC05U (E)-L	2368 (end case)

Width 1080 mm; Height 2200 mm
Handrail height 450 mm

Model	Length (mm)
FPW-EXC2064 (E)-L	1875
FPW-EXC2084 (E)-L	2500
FPW-EXC2024 (E)-L	3750
FPW-EXC204U (E)-L	2368 (end case)

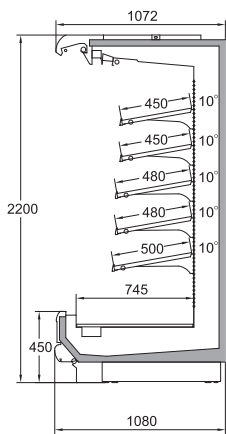
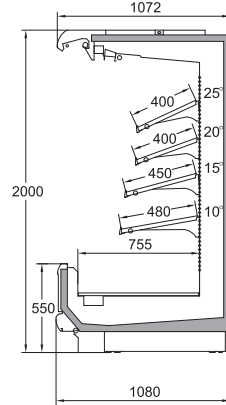
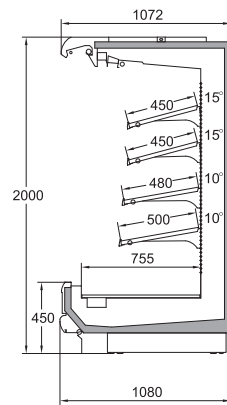
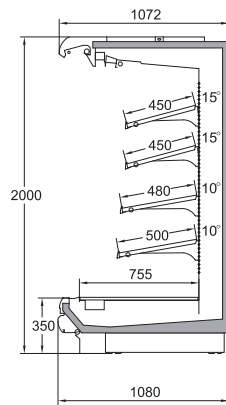

Width 880 mm; Height 2000 mm
Handrail height 350 mm

Model	Length (mm)
FPW-EXC0863 (E)-L	1875
FPW-EXC0883 (E)-L	2500
FPW-EXC0823 (E)-L	3750

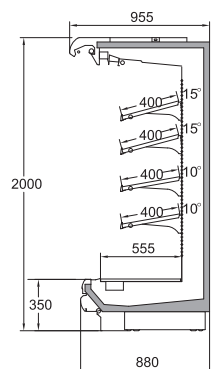

Width 880 mm; Height 2000 mm
Handrail height 450 mm

Model	Length (mm)
FPW-EXC0864 (E)-L	1875
FPW-EXC0884 (E)-L	2500
FPW-EXC0824 (E)-L	3750

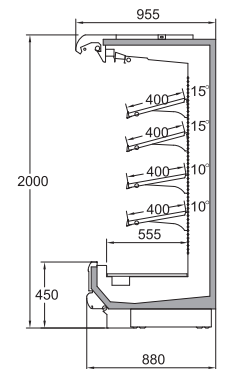

Multi-deck showcase



CPW-EXC084PD (E)-L Multi-deck showcase Dairy product & Daily <Fresh>

3°C to 7°C • Remote type
• Reach-in type

FPW-EXC084PD (E)-L Multi-deck showcase Fish & Meat

0°C to 4°C • Remote type
• Reach-in type

Width 1080 mm; Height 2000 mm
Handrail height 450 mm

Model	Length (mm)
CPW-EXC064PD (E)-L	1875
CPW-EXC084PD (E)-L	2500
CPW-EXC024PD (E)-L	3750
CPW-EXC04UPD (E)-L	2368 (end case)

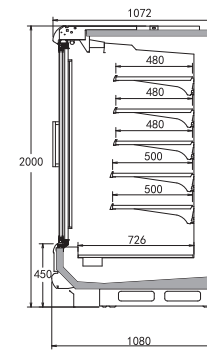

*Side panel in the picture is optional

Width 1080 mm; Height 2000 mm
Handrail height 450 mm

Model	Length (mm)
FPW-EXC064PD (E)-L	1875
FPW-EXC084PD (E)-L	2500
FPW-EXC024PD (E)-L	3750
FPW-EXC04UPD (E)-L	2368 (end case)

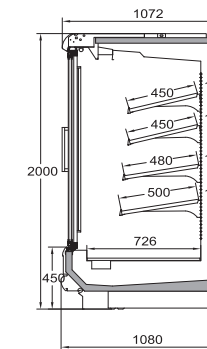



FEW-EXC9065 (E)-L FEW-EXC9865 (E)-L Multi-deck showcase Fish & Meat

-2°C to 2°C

- Built-in type
- 50Hz only

Width 1080 mm; Height 1930 mm	
Handrail height 550 mm	
Model	Length (mm)
FEW-EXC9065 (E)-L	1875

Power consumption		Refrigerant	Defrost type
Operating	2200W(380V) 263W(220V)	R404A	Temperature controlled heating wire defrosting
Defrosting	1280W(380V) -		
Lighting	- 100W		

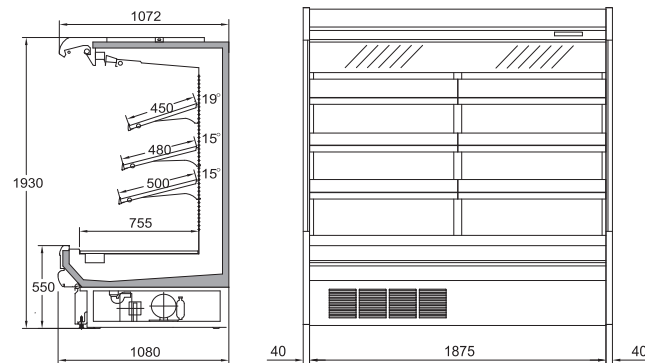

Width 880 mm; Height 1930 mm	
Handrail height 550 mm	
Model	Length (mm)
FEW-EXC9865 (E)-L	1875

Power consumption		Refrigerant	Defrost type
Operating	2200W(380V) 263W(220V)	R404A	Temperature controlled heating wire defrosting
Defrosting	1280W(380V) -		
Lighting	- 100W		

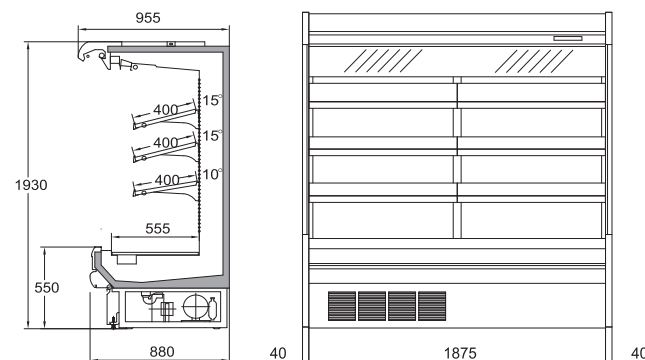

Select table for Multi-deck showcase models (CPW/FPW/FEW series)

Model	Deluxe side panels	Regular side panels		Mirror side panels	
		Sprayed edges	Stainless-steel edges	Sprayed edges	Stainless-steel edges
CPW-EXC063 (E)-L/083 (E)-L/023 (E)-L/03U(E)-L	MER-EXC03AL/AR	MER-EXC03L-A/R-A	MER-EXC03L-S/R-S	ME-EXC03L-A/R-A	ME-EXC03L-S/R-S
FPW-EXC063 (E)-L/083 (E)-L/023 (E)-L/03U(E)-L	MER-EXC03AL/AR	MER-EXC03L-A/R-A	MER-EXC03L-S/R-S	ME-EXC03L-A/R-A	ME-EXC03L-S/R-S
CPW-EXC064 (E)-L/084 (E)-L/024 (E)-L/04U(E)-L	MER-EXC04AL/AR	MER-EXC04L-A/R-A	MER-EXC04L-S/R-S	ME-EXC04L-A/R-A	ME-EXC04L-S/R-S
FPW-EXC064 (E)-L/084 (E)-L/024 (E)-L/04U(E)-L	MER-EXC04AL/AR	MER-EXC04L-A/R-A	MER-EXC04L-S/R-S	ME-EXC04L-A/R-A	ME-EXC04L-S/R-S
CPW-EXC065 (E)-L/085 (E)-L/025 (E)-L/05U(E)-L	MER-EXC05AL/AR	MER-EXC05L-A/R-A	MER-EXC05L-S/R-S	ME-EXC05L-A/R-A	ME-EXC05L-S/R-S
FPW-EXC065 (E)-L/085 (E)-L/025 (E)-L/05U(E)-L	MER-EXC05AL/AR	MER-EXC05L-A/R-A	MER-EXC05L-S/R-S	ME-EXC05L-A/R-A	ME-EXC05L-S/R-S
CPW-EXC0863(E)-L / 0883(E)-L / 0823(E)-L	MER-EXC83AL / AR	MER-EXC83L-A / R-A	MER-EXC83L-S / R-S	ME-EXC83L-A / R-A	ME-EXC83L-S / R-S
FPW-EXC0863(E)-L / 0883(E)-L / 0823(E)-L	MER-EXC83AL / AR	MER-EXC83L-A / R-A	MER-EXC83L-S / R-S	ME-EXC83L-A / R-A	ME-EXC83L-S / R-S
CPW-EXC0864 (E)-L/0884 (E)-L/0824 (E)-L	MER-EXC84AL/AR	MER-EXC84L-A/R-A	MER-EXC84L-S/R-S	ME-EXC84L-A/R-A	ME-EXC84L-S/R-S
FPW-EXC0864 (E)-L/0884 (E)-L/0824 (E)-L	MER-EXC84AL/AR	MER-EXC84L-A/R-A	MER-EXC84L-S/R-S	ME-EXC84L-A/R-A	ME-EXC84L-S/R-S
CPW-EXC2064 (E)-L/2084 (E)-L/2024 (E)-L/204U(E)-L	MER-EXC204AL/AR	MER-EXC204L-A/R-A	MER-EXC204L-S/R-S	ME-EXC204L-A/R-A	ME-EXC204L-S/R-S
FPW-EXC2064 (E)-L/2084 (E)-L/2024 (E)-L/204U(E)-L	MER-EXC204AL/AR	MER-EXC204L-A/R-A	MER-EXC204L-S/R-S	ME-EXC204L-A/R-A	ME-EXC204L-S/R-S
CPW-EXC064PD (E)-L/084PD (E)-L/024PD (E)-L/04UPD(E)-L	FPW-EXC04AELPDL / AERPDL	-	-	FPW-EXC04EMLPDL-A / EIMRPDL-A	-
FPW-EXC064PD (E)-L/084PD (E)-L/024PD (E)-L/04UPD(E)-L	FPW-EXC04AELPDL/AERPDL	-	-	FPW-EXC04EMLPDL-A/EIMRPDL-A	-
FEW-EXC9065 (E)-L	-	FEW-EXC9065EL-A/ER-A	FEW-EXC9065EL-S/ER-S	-	-
FEW-EXC9865 (E)-L	-	FEW-EXC9865EL-A/ER-A	FEW-EXC9865EL-S/ER-S	-	-

Select table for mirrored models

Mirrored model	Specification	Applicable display-case length		
		1875 mm	End case	2500 mm 3750 mm
M-EXC200	Width 200 mm			●
M-EXC202	Width 200 mm			●
M-EXC206	Width 200 mm	●		
M-EXC207	Width 200 mm		●	
M-EXC280	Width 280 mm			●
M-EXC282	Width 280 mm			●
M-EXC286	Width 280 mm	●		
M-EXC287	Width 280 mm		●	
M-EXC350	Width 350 mm			●
M-EXC352	Width 350 mm	●		
M-EXC356	Width 350 mm		●	
M-EXC357	Width 350 mm		●	
M-EXC420	Width 420 mm			●
M-EXC422	Width 420 mm			●
M-EXC426	Width 420 mm	●		
M-EXC427	Width 420 mm		●	
M-EXC460	Width 460 mm			●
M-EXC462	Width 460 mm			●
M-EXC466	Width 460 mm	●		
M-EXC467	Width 460 mm		●	

Mirror width and angle options FPW/CPW/CVS/FPS/CPS/CSM series

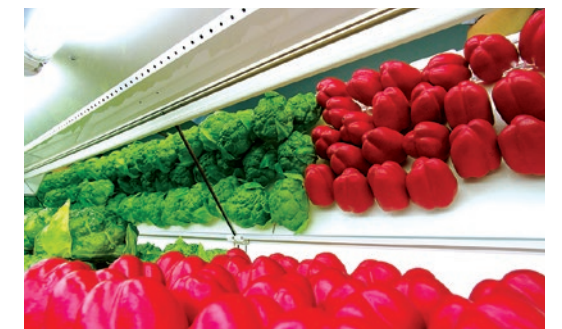
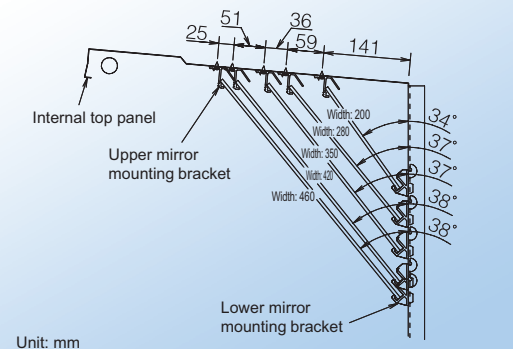

Features and options for Semi-multi-deck showcase

Features:

- All-metal exterior, soft lines, and a simple and rich texture
- Micro-computer digital-display temperature controller
- Energy-saving rectifier
- Energy-saving, double air curtain design
- Adjustable shelves
- Standardly equipped with price tag covers that are guaranteed to protect the tags and are easy for customers to view
- Refrigerant: R404A, and R407F
- Standardly LED lighting

Options:

- Mirror
- Covered support truss
- Guard for the return-air-vent shelf
- ESM speed-adjustable, energy-saving fan
- Additional glass shelf guards
- Anti-reflective shelves
- Aluminum-sheet night curtain
- External lighting
- Covered stepped truss
- Additional glass-panel handrail
- Customizable exterior color
- Various side panels

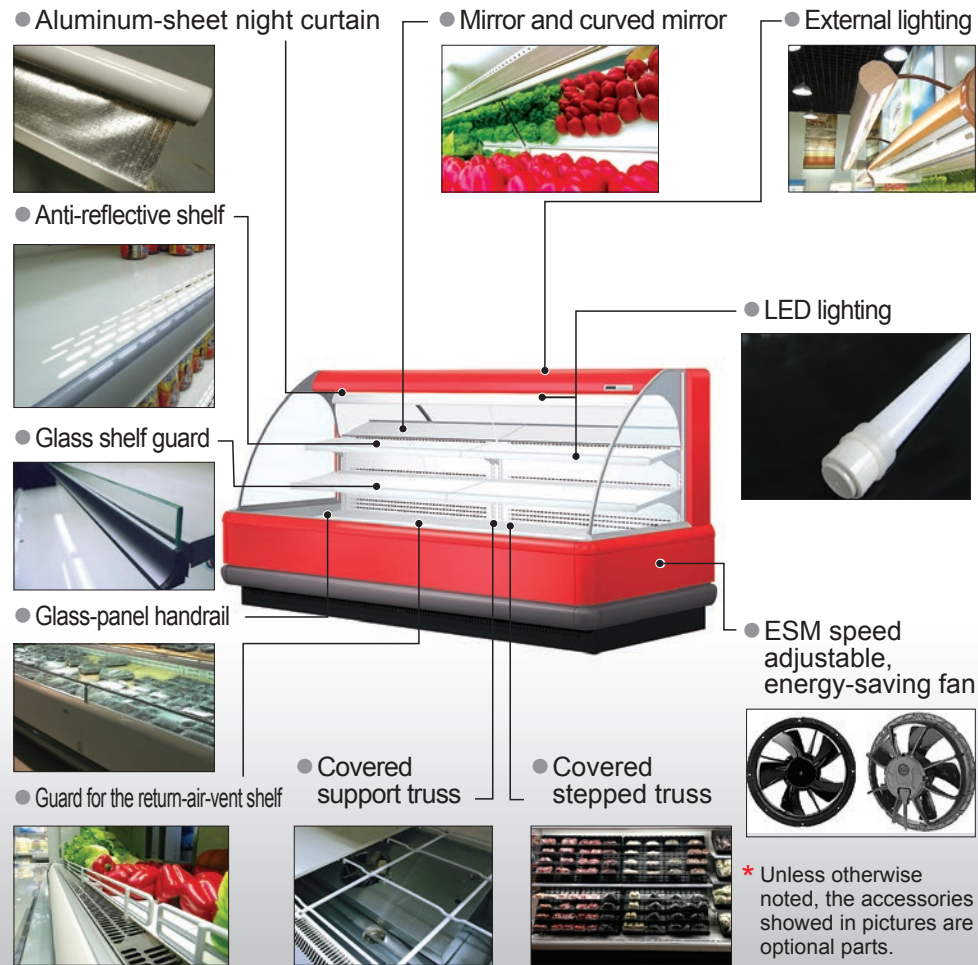

* Unless otherwise noted, the accessories showed in pictures are optional parts.

Width 1080 mm; Height 1500 mm	
Handrail height 450 mm	
Model	Length (mm)
CPS-EXC5064 (E)-L	1875
CPS-EXC5084 (E)-L	2500
CPS-EXC5024 (E)-L	3750
CPS-EXC504EN(E)-L	2368(end case)
CPS-EXC504U (E)-L	2360 (island end case)
CPS-EXC504CL(E)-L	left corner
CPS-EXC504CR(E)-L	right corner

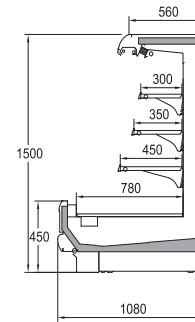

Width 1080 mm; Height 1700 mm	
Handrail height 350 mm	
Model	Length (mm)
CPS-EXC7063 (E)-L	1875
CPS-EXC7083 (E)-L	2500
CPS-EXC7023 (E)-L	3750
CPS-EXC703EN (E)-L	2368(end case)
CPS-EXC703U (E)-L	2360 (island end case)

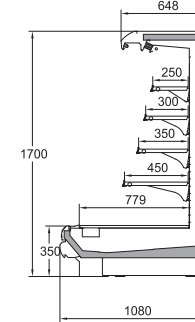

Width 1080 mm; Height 1700 mm	
Handrail height 450 mm	
Model	Length (mm)
CPS-EXC7064 (E)-L	1875
CPS-EXC7084 (E)-L	2500
CPS-EXC7024 (E)-L	3750
CPS-EXC704EN (E)-L	2368(end case)
CPS-EXC704U (E)-L	2360 (island end case)

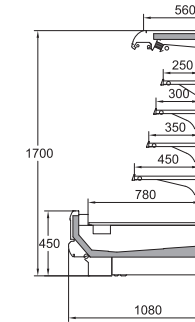

Width 880 mm; Height 1500 mm	
Handrail height 450 mm	
Model	Length (mm)
CPS-EXC5864 (E)-L	1875
CPS-EXC5884 (E)-L	2500
CPS-EXC5824 (E)-L	3750
CPS-EXC584EN (E)-L	1880(end case)
CPS-EXC584U (T)(E)-L	1960 (island end case)

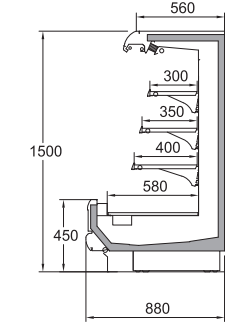

CPS-EXC7084 (E)-L CPS-EXC5884 (E)-L Semi-multi-deck showcase Dairy product & Daily <Fresh>

3°C to 7°C • Remote type

- Operating temperature for U-type, CL-type, and CR-type refrigerated display cases: 5°C to 12°C

EN type end display case • Deluxe side panels

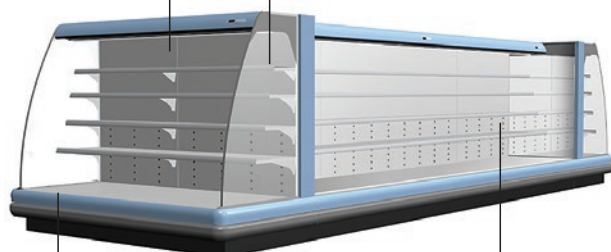

● A relatively low handrail height increases the display area ● Linearly connected display cases

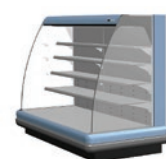

CPS-EXC***EN types

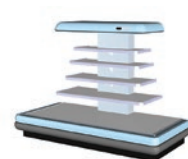

CPS-EXC***U types

Illustration of the differences between EN and U type end display cases



Semi-multi-deck showcase

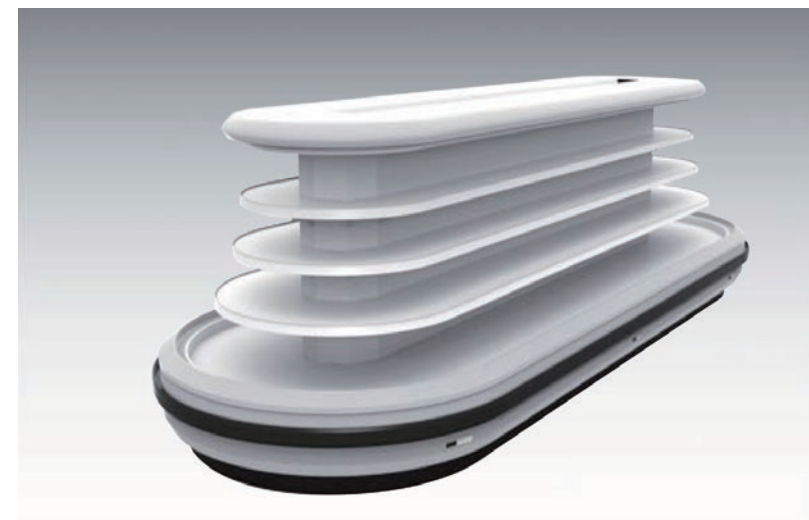

CPS-EXC5884C(E)-L CPS-EXC7884C(E)-L Round type Semi-multi deck showcase Dairy & Daily

3°C to 7°C • Remote type

- Operating temperature for End cases: 3°C to 10°C

Width 919.5 mm; Height 1500 mm
Handrail height 450 mm

Model	Length (mm)
CPS-EXC5884C(E)-L	1875
CPS-EXC5884C(E)-L	2500
CPS-EXC5824C(E)-L	3750
CPS-EXC584CU(E)-L	2030 (end case)

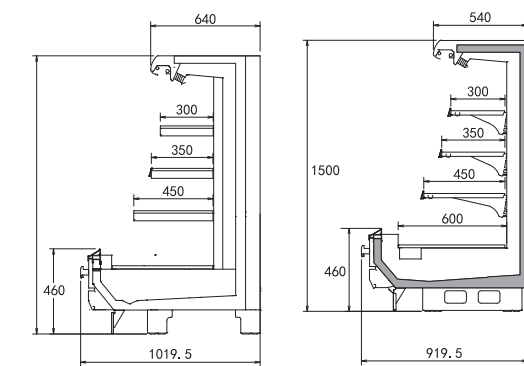

Width 919.5 mm; Height 1700 mm
Handrail height 450 mm

Model	Length (mm)
CPS-EXC7864C(E)-L	1875
CPS-EXC7884C(E)-L	2500
CPS-EXC7824C(E)-L	3750
CPS-EXC784CU(E)-L	2030 (end case)

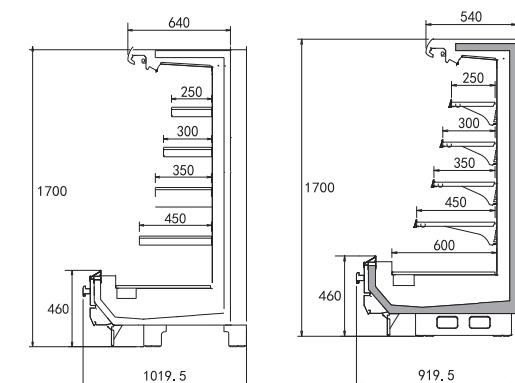

Semi-multi-deck showcase



FPS-EXC3084 (E)-L FPS-EXC3885 (E)-L Semi-multi-deck showcase Fish & Meat

-2°C to 2°C • Remote type

- Operating temperature for U-type, refrigerated display cases: 5°C to 12°C

Width 1080 mm; Height 1350 mm
Handrail height 450 mm

Model	Length (mm)
FPS-EXC3064 (E)-L	1875
FPS-EXC3084 (E)-L	2500
FPS-EXC3024 (E)-L	3750
FPS-EXC304U (E)-L	2360 (island end case)

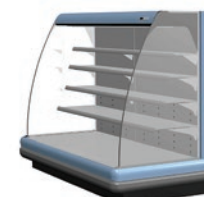
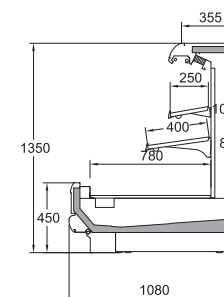

FPS-EXC***EN types

Width 1080 mm; Height 1350 mm
Handrail height 550 mm

Model	Length (mm)
FPS-EXC3065 (E)-L	1875
FPS-EXC3085 (E)-L	2500
FPS-EXC3025 (E)-L	3750
FPS-EXC305EN (E)-L	2368 (end case)
FPS-EXC305U (E)-L	2360 (island end case)

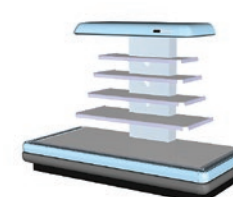
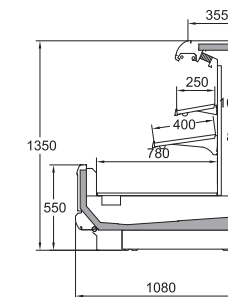

FPS-EXC***U types

Illustration of the differences between EN and U type end display cases

Width 1080 mm; Height 1500 mm
Handrail height 550 mm

Model	Length (mm)
FPS-EXC5065 (E)-L	1875
FPS-EXC5085 (E)-L	2500
FPS-EXC5025 (E)-L	3750
FPS-EXC505U (E)-L	2360 (island end case)

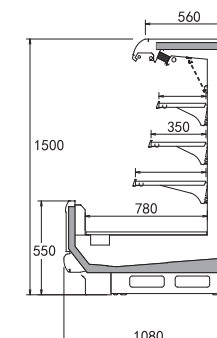

Width 880 mm; Height 1350 mm
Handrail height 550 mm

Model	Length (mm)
FPS-EXC3865 (E)-L	1875
FPS-EXC3885 (E)-L	2500
FPS-EXC3825 (E)-L	3750
FPS-EXC385U(T)-L	1960 (island end case)

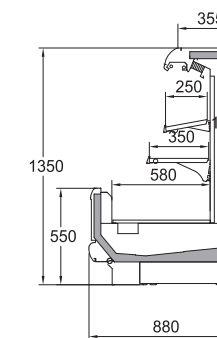

FPS-EXC3085PI(E)T-L Semi-multi-deck showcase Fish & Meat

0°C to 4°C • Built-in type

Width 1080 mm; Height 1495 mm
Handrail height 695 mm

Model	Length (mm)	Power consumption	Refrigerant	Defrost type	
FPS-EXC3065PI (E)T-L	1875	Operating	1500W(380V) 223.5W(220V)	R404A	Electric heating
		Defrosting	1120W(380V)		
		Lighting	- 60W		
FPS-EXC3085PI (E)T-L	2500	Operating	2200W(380V) 305.5W(220V)		
		Defrosting	-		
		Lighting	- 78W		

Width 880 mm; Height 1495 mm
Handrail height 695 mm

Model	Length (mm)	Power consumption	Refrigerant	Defrost type	
FPS-EXC3865PI (E)T-L	1875	Operating	1500W(380V) 223.5W(220V)	R404A	Electric heating
		Defrosting	1120W(380V)		
		Lighting	- 60W		

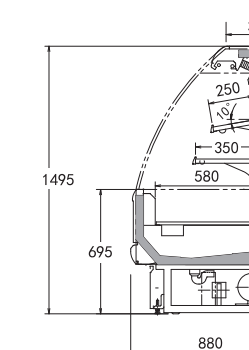
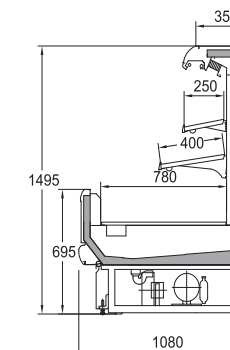

Select table for Semi-multi-deck showcase models (CPS/FPS series)

Model	Deluxe side panels	Regular side panels		Mirror side panel	
		Sprayed edges	Stainless-steel edges	Sprayed edges	Stainless-steel edges
CPS-EXC5064 (E)-L/5084 (E)-L/5024 (E)-L	CPS-EXC504AEL CPS-EXC504AER	CPS-EXC504EL-A CPS-EXC504ER-A	CPS-EXC504EL-S CPS-EXC504ER-S	CPS-EXC504EML-A CPS-EXC504EMR-A	CPS-EXC504EML-S CPS-EXC504EMR-S
CPS-EXC504U (E)-L/504EN(E)-L/504CL(E)-L/504CR(E)-L	CPS-EXC704AEL CPS-EXC704AER	CPS-EXC704EL-A CPS-EXC704ER-A	CPS-EXC704EL-S CPS-EXC704ER-S	CPS-EXC704EML-A CPS-EXC704EMR-A	CPS-EXC704EML-S CPS-EXC704EMR-S
CPS-EXC7064 (E)-L/7084 (E)-L/7024 (E)-L CPS-EXC704EN (E)-L/704U (E)-L	CPS-EXC703AEL/ AER	CPS-EXC703EL-A/ ER-A	CPS-EXC703EL-S/ ER-S	CPS-EXC703EML-A/ EMR-A	CPS-EXC703EML-S/ EMR-S
CPS-EXC5864 (E)-L/5884 (E)-L/5824 (E)-L CPS-EXC584EN (E)-L/584U (E)-L	CPS-EXC584AEL/ AER	CPS-EXC584EL-A/ ER-A	CPS-EXC584EL-S/ ER-S	CPS-EXC584EML-A/ EMR-A	CPS-EXC584EML-S/ EMR-S
FPS-EXC3064(E)-L/3084(E)-L/3024(E)-L/304U(E)-L	FPS-EXC304AEL/ AER	FPS-EXC304EL-A/ ER-A	FPS-EXC304EL-S/ ER-S	FPS-EXC304EML-A/ EMR-A	FPS-EXC304EML-S/ EMR-S
FPS-EXC5065(E)-L/5085(E)-L/5025(E)-L/505U(E)-L	FPS-EXC505AEL/ AER	FPS-EXC505EL-A/ ER-A	FPS-EXC505EL-S/ ER-S	FPS-EXC505EML-A/ EMR-A	FPS-EXC505EML-S/ EMR-S
FPS-EXC3865(E)-L/3885(E)-L/3825(E)-L/385U(T)(E)-L	FPS-EXC385AEL/ AER	FPS-EXC385EL-A/ ER-A	FPS-EXC385EL-S/ ER-S	FPS-EXC385EML-A/ EMR-A	FPS-EXC385EML-S/ EMR-S
FPS-EXC3065PI(E)T-L/3085PI(E)T-L	-	FPS-EXC305EL-A/ ER-A	FPS-EXC305EL-S/ ER-S	FPS-EXC305EML-A/ EMR-A	FPS-EXC305EML-S/ EMR-S
FPS-EXC3865PI(E)T-L	-	FPS-EXC385EL-A/ ER-A	FPS-EXC385EL-S/ ER-S	FPS-EXC385EML-A/ EMR-A	FPS-EXC385EML-S/ EMR-S
FPS-EXC3065 (E)-L/3085 (E)-L/3025 (E)-L	FPS-EXC305AEL/ AER	FPS-EXC305EL-A/ ER-A	FPS-EXC305EL-S/ ER-S	FPS-EXC305EML-A/ EMR-A	FPS-EXC305EML-S/ EMR-S
FPS-EXC305EN (E)-L/305U (E)-L					

Select table for mirrored models

Mirrored model	Specification	Applicable display-case length		
		1875 mm	End case 2500 mm	3750 mm
M-EXC200	Width 200 mm			
M-EXC202	Width 200 mm			
M-EXC206	Width 200 mm	●		
M-EXC207	Width 200 mm		●	
M-EXC280	Width 280 mm			●
M-EXC282	Width 280 mm			●
M-EXC286	Width 280 mm	●		
M-EXC287	Width 280 mm		●	
M-EXC350	Width 350 mm			●
M-EXC352	Width 350 mm			●
M-EXC356	Width 350 mm	●		
M-EXC357	Width 350 mm		●	
M-EXC420	Width 420 mm			●
M-EXC422	Width 420 mm	●		
M-EXC427	Width 420 mm		●	
M-EXC460	Width 460 mm			●
M-EXC462	Width 460 mm			●
M-EXC466	Width 460 mm	●		
M-EXC467	Width 460 mm		●	

Mirror width and angle options
FPW/CPW/CVS/FPS/CPS/CSM series

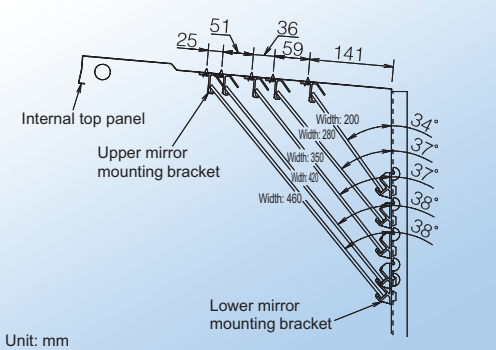

Features and options for CZR

- Features:**
- All-metal exterior, soft lines, and a simple and rich texture
 - Micro-computer digital-display temperature controller
 - Energy-saving rectifier
 - Standardly equipped with LED exterior lights
 - Standardly equipped with LED lighting for the top compartment and interior LED low-temperature lighting for the bottom compartment
 - Adjustable shelves for the top compartment
 - Standardly equipped with price tag covers that are guaranteed to protect the tags and are easy for customers to view
 - Refrigerant: R404A, and R407F
- Options:**
- ESM speed-adjustable, energy-saving fan for the bottom compartment
 - Interior dividing truss for the bottom compartment
 - Customizable exterior color
 - Various side panels

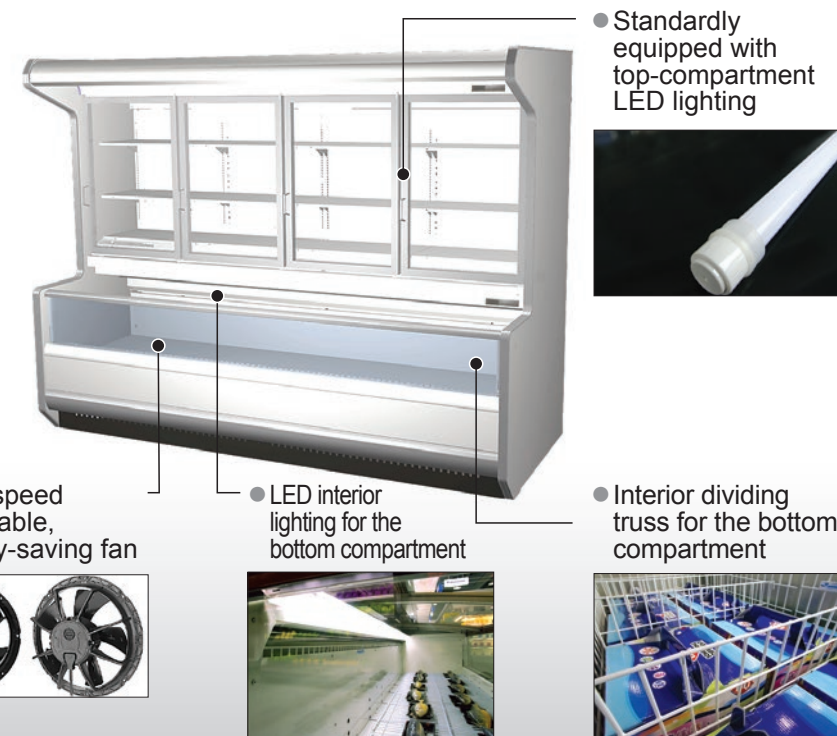

* Unless otherwise noted, the accessories showed in pictures are optional parts.

CZR-EXC087 (E)-L CZR-EXC087SD(E)-L Dual type freezer showcase Frozen foods

- 22°C to -18°C
- Remote type
- Combined cabinet

Width 1110 mm; Height 2000 mm
Height of the bottom compartment 790 mm

Model	Length (mm)
CZR-EXC067 (E)-L	1875
CZR-EXC087 (E)-L	2500
CZR-EXC07U (E)-L	2405 (end case)

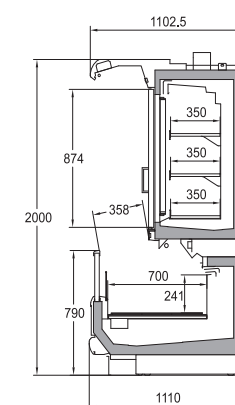

Width 1110 mm; Height 2000 mm
Height of the bottom compartment 820 mm

Model	Length (mm)
CZR-EXC067SD (E)-L	1875
CZR-EXC087SD (E)-L	2500
CZR-EXC07USD (E)-L	2405 (end case)

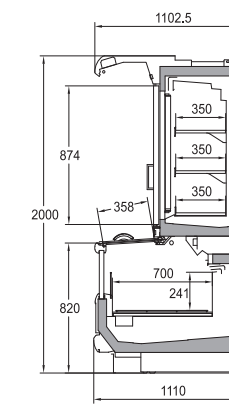

Select table for side-panel model Dual type freezer showcase (CZR series)

Model	Regular side panels	
	Sprayed edges	Stainless-steel edges
CZR-EXC067 (E)-L/087 (E)-L/07U (E)-L	CZR-EXC07EL-A/ER-A	CZR-EXC07EL-S/ER-S
CZR-EXC067SD (E)-L/087SD (E)-L/07USD (E)-L	CZR-EXC07ELSD-A/ERSD-A	CZR-EXC07ELSD-S/ERSD-S

Features and options for the EXC-series FLD Reach-in show case

Features:

- All-metal exterior, soft lines, and a simple and rich texture
- Micro-computer digital-display temperature controller
- Uses all-new hidden-frame display doors to increase the effectiveness of the display
- The standard configuration has an antifogging display door to reduce energy consumption and guarantee display effectiveness.
- Highly effective dual defrosting heating pipes
- Standardly equipped with a case top advertising panel
- Adjustable shelves
- Standardly equipped with price tag covers that are guaranteed to protect the tags and are easy for customers to view
- Refrigerant: R404A, and R407F
- Standardly vertical LED lighting

Options:

- ESM speed-adjustable, energy-saving fan
- Various side panels

- Standardly equipped with case top advertising panel



- Vertical LED lighting



- ESM speed-adjustable, energy-saving fan



* Unless otherwise noted, the accessories shown in pictures are optional parts.



FLD-EXC092L (E) FLD-EXC092CL (E) Reach-in showcase Frozen foods

L: -22°C to -18°C

Width 950 mm; Height 2000 mm

Glass-door height 1660 mm

Model	Length (mm)
FLD-EXC092L(E)	1552(2doors)
FLD-EXC093L(E)	2328(3doors)
FLD-EXC094L(E)	3104(4doors)
FLD-EXC095L(E)	3880(5doors)
FLD-EXC092CL(E)	1947(end case)

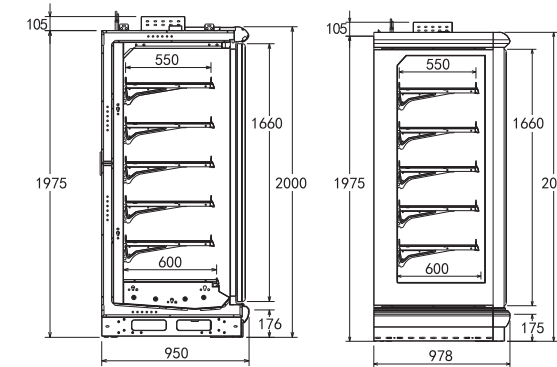

FLD-EXC092M (E) FLD-EXC092CM (E) Reach-in showcase Frozen foods

M: -1°C to 7°C

- Remote type
- Reach-in type

- FLD full series high-efficiency products

Width 950 mm; Height 2000 mm

Glass-door height 1660 mm

Model	Length (mm)
FLD-EXC092M(E)	1552(2doors)
FLD-EXC093M(E)	2328(3doors)
FLD-EXC094M(E)	3104(4doors)
FLD-EXC095M(E)	3880(5doors)
FLD-EXC092CM(E)	1974(end case)

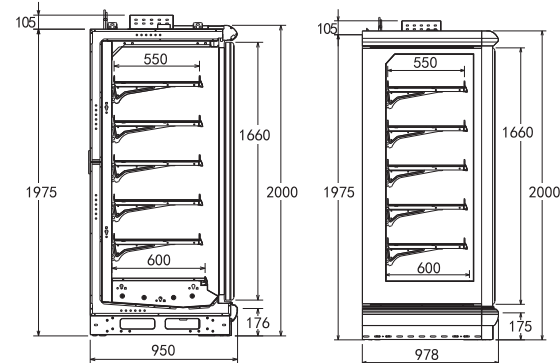

Door frame color variations

- Black
- Silver



Select table for side-panel model Reach-in freezer display cases (FLD series)

Model	Deluxe side panels	Regular side panels		Mirror side panels	
		Sprayed edges	Stainless-steel edges	Sprayed edges	Stainless-steel edges
FLD-EXC092M(E)/093M(E)/094M(E)/095M(E) FLD-EXC092L(E)/093L(E)/094L(E)/095L(E)	FLD-EXC09BEG(L)/ BEG(R)	RIF-EXC09BEL/BER	-	-	-



Features and options for TVQ

Features:

- All-metal exterior, soft lines, and a simple and rich texture
- Micro-computer digital-display temperature controller
- Optional non-cooled shelf for expanding the main display space
- Standardly equipped with price tag covers that are guaranteed to protect the tags and are easy for customers to view
- Refrigerant: R404A, and R407F
- Standardly interior LED lighting

Options:

- Non-cooled shelf
- ESM speed-adjustable, energy-saving fan
- Interior dividing truss
- Installable glass door for the open-style refrigerated case
- Cross bar POP label stander
- Sliding-door limiter
- Customizable exterior color
- Various side panels

● Non-cooled shelf



● Cross bar POP label stander



● Sealable display doors



● Interior LED lighting



● Interior dividing truss



● Sliding-door limiter



● ESM speed-adjustable, energy-saving fan



* Unless otherwise noted, the pictured accessories are optional parts.

TVQ-EXC087P (E) TVQ-EXC087U (E) Island freezer showcase Frozen food

-22°C to -18°C • Remote type



Width: 1213 mm; Handrail height 790 mm

Loaded depth 305 mm

Model	Length (mm)
TVQ-EXC067P (E)	1875
TVQ-EXC087P (E)	2500
TVQ-EXC027P (E)	3750

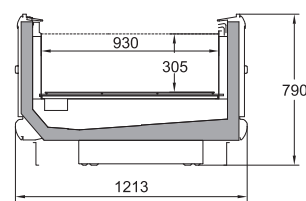

Width: 1513 mm; Handrail height 790 mm

Loaded depth 300 mm

Model	Length (mm)
TVQ-EXC067U (E)	1875
TVQ-EXC087U (E)	2500
TVQ-EXC027U (E)	3750

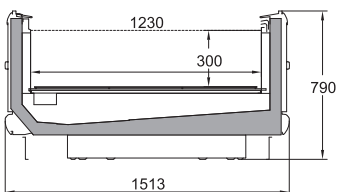

TVQ-EXC089WF (E) TVQ-EXC089KF (E) TVQ-EXC089LF (E) Island freezer showcase Frozen food

-22°C to -18°C • Remote type



Width 1500 mm; Handrail height 900 mm

Loaded depth 370 mm

Model	Length (mm)
TVQ-EXC069WF (E)	1875
TVQ-EXC089WF (E)	2500
TVQ-EXC029WF (E)	3750

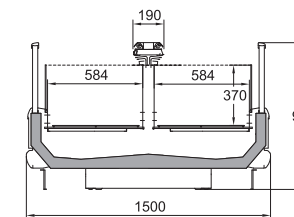

Width 1800 mm; Handrail height 900 mm

Loaded depth 370 mm

Model	Length (mm)
TVQ-EXC069KF (E)	1875
TVQ-EXC089KF (E)	2500
TVQ-EXC029KF (E)	3750

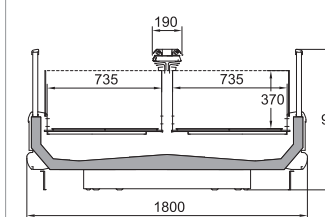

Width 2000 mm; Handrail height 900 mm

Loaded depth 370 mm

Model	Length (mm)
TVQ-EXC069LF (E)	1875
TVQ-EXC089LF (E)	2500
TVQ-EXC029LF (E)	3750

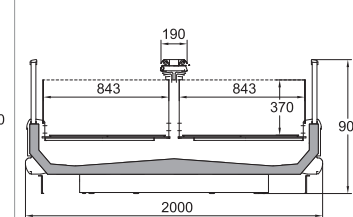

Width 1080 mm; Handrail height 900 mm

Loaded depth 370 mm

Model	Length (mm)
TVQ-EXCCWF (E)	1500 (end case)
TVQ-EXCCKF (E)	1800 (end case)
TVQ-EXCCLF (E)	2000 (end case)

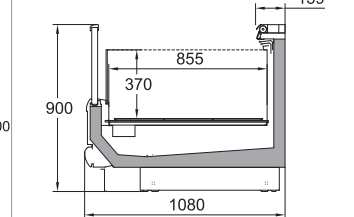

Select table for side-panel model island freezer showcase (TVQ series)

Model	Deluxe side panels	Regular side panels	
		Sprayed edges	Stainless steel edges
TVQ-EXC067P(E)/087P(E)/027P(E)	-	TVQ-EXC07PE1-A	TVQ-EXC07PE1-S
TVQ-EXC067U(E)/087U(E)/027U(E)	-	TVQ-EXC07UE1-A	TVQ-EXC07UE1-S
TVQ-EXC069KF (E)/089KF (E)/029KF (E)	TVQ-EXCKFAE(E)	TVQ-EXCKFE1-A	TVQ-EXCKFE1-S
TVQ-EXC069LF (E)/089LF (E)/029LF (E)	TVQ-EXCLFAE(E)	TVQ-EXCLFE1-A	TVQ-EXCLFE1-S
TVQ-EXC069WF (E)/089WF (E)/029WF (E)	TVQ-EXCWFAE(E)	TVQ-EXCWFE1-A	TVQ-EXCWFE1-S
TVQ-EXC069KFVSD (E)/089KFVSD (E)/029KFVSD (E)	TVQ-EXCKFAESD	TVQ-EXCKFE1SD-A	TVQ-EXCKFE1SD-S
TVQ-EXC069LFVSD (E)/089LFVSD (E)/029LFVSD (E)	TVQ-EXCLFAESD	TVQ-EXCLFE1SD-A	TVQ-EXCLFE1SD-S
TVQ-EXC069WFVSD (E)/089WFVSD (E)/029WFVSD (E)	TVQ-EXCWFAESD	TVQ-EXCWFE1SD-A	TVQ-EXCWFE1SD-S
TVQ-EXC069KFVSD(SE)/089KFVSD(SE)/029KFVSD(SE)	TVQ-EXCKFAEVSD(S)	TVQ-EXCKFE1VSD-A(S)	TVQ-EXCKFE1VSD-A(S)
TVQ-EXC069WFVSD (SE)/089WFVSD (SE)/029WFVSD (SE)	-	TVQ-EXCWFE1SD(S)-A	TVQ-EXCWFE1SD(S)-S
TVQ-EXC069KFVSD (SE)/089KFVSD (SE)/029KFVSD (SE)	-	TVQ-EXCKFE1SD(S)-A	TVQ-EXCKFE1SD(S)-S
TVQ-EXC069LFVSD (SE)/089LFVSD (SE)/029LFVSD (SE)	-	TVQ-EXCLFE1SD(S)-A	TVQ-EXCLFE1SD(S)-S
TVQ-EXC069WFVSD(E)/089WFVSD(E)/029WFVSD(E)	TVQ-EXCWFAEVSD	TVQ-EXCWFE1VSD-A	TVQ-EXCWFE1VSD-S
TVQ-EXC069WFVSD(SE)/089WFVSD(SE)/029WFVSD(SE)	TVQ-EXCWFAEVSD(S)	TVQ-EXCWFE1VSD(S)-A	TVQ-EXCWFE1VSD(S)-S
TVQ-EXC069KFVSD(E)/089KFVSD(E)/029KFVSD(E)	TVQ-EXCKFAEVSD	TVQ-EXCKFE1VSD-A	TVQ-EXCKFE1VSD-A
TVQ-EXC069LFVSD(E)/089LFVSD(E)/029LFVSD(E)	TVQ-EXCLFAEVSD	TVQ-EXCLFE1VSD-A	TVQ-EXCLFE1VSD-S
TVQ-EXC069LFVSD (SE)/089LFVSD (SE)/029LFVSD (SE)	TVQ-EXCLFAEVSD(S)	TVQ-EXCLFE1VSD(S)-A	TVQ-EXCLFE1VSD(S)-S

Island freezer showcase

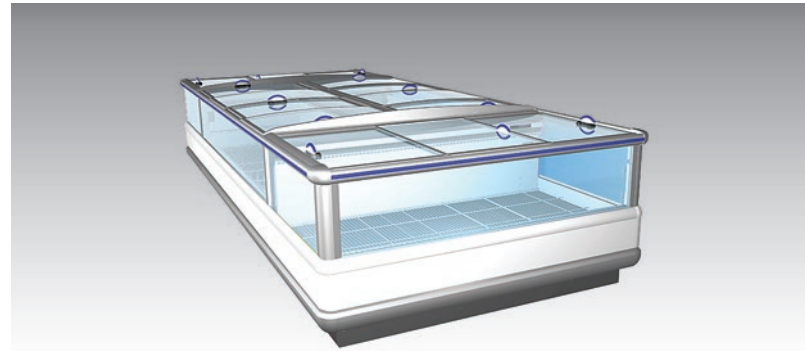

TVQ-EXC089WFSD (E)
TVQ-EXC089KFSD (E)
TVQ-EXC089LFSD (E)
Island freezer showcase
Frozen food

-22°C to -18°C • Remote type
 • Sliding sideways glass doors

Width 1500 mm; Handrail height 930 mm
 Loaded depth 370 mm

Product dimensions	Model	Length (mm)
	TVQ-EXC069WFSD (E)	1875
	TVQ-EXC089WFSD (E)	2500
	TVQ-EXC029WFSD (E)	3750

Non-cooled shelves are available for the following products

Product dimensions	Model	Length (mm)
	TVQ-EXC069WFSD (SE)	1875
	TVQ-EXC089WFSD (SE)	2500
	TVQ-EXC029WFSD (SE)	3750

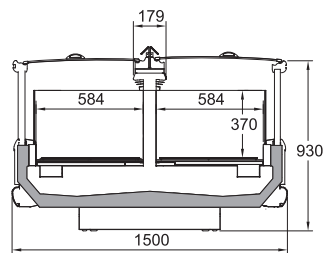

Width 1800 mm; Handrail height 930 mm
 Loaded depth 370 mm

Product dimensions	Model	Length (mm)
	TVQ-EXC069KFSD (E)	1875
	TVQ-EXC089KFSD (E)	2500
	TVQ-EXC029KFSD (E)	3750

Non-cooled shelves are available for the following products

Product dimensions	Model	Length (mm)
	TVQ-EXC069KFSD (SE)	1875
	TVQ-EXC089KFSD (SE)	2500
	TVQ-EXC029KFSD (SE)	3750

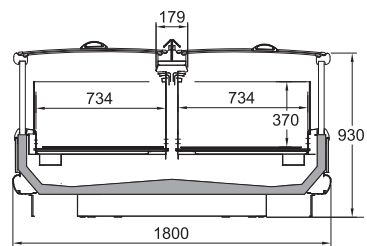

Width 2000 mm; Height 930 mm
 Loaded depth 370 mm

Product dimensions	Model	Length (mm)
	TVQ-EXC069LFSD (E)	1875
	TVQ-EXC089LFSD (E)	2500
	TVQ-EXC029LFSD (E)	3750

Non-cooled shelves are available for the following products

Product dimensions	Model	Length (mm)
	TVQ-EXC069LFSD (SE)	1875
	TVQ-EXC089LFSD (SE)	2500
	TVQ-EXC029LFSD (SE)	3750

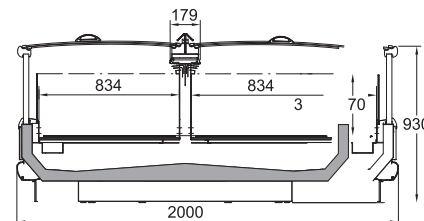

Island freezer showcase

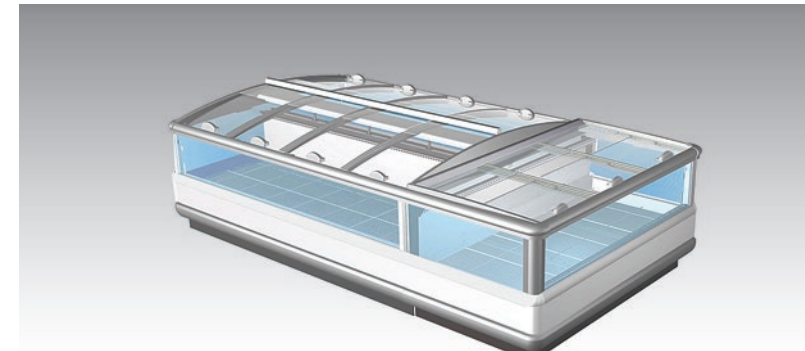

TVQ-EXC089WFVSD (E)
TVQ-EXC089KFVSD (E)
TVQ-EXC089LFVSD (E)
Island freezer showcase
Frozen food

-22°C to -18°C • Remote type
 • Sliding up glass doors

Width 1500 mm; Handrail height 935 mm
 Loaded depth 370 mm

Product dimensions	Model	Length (mm)
	TVQ-EXC069WFVSD(E)	1875
	TVQ-EXC089WFVSD(E)	2500
	TVQ-EXC029WFVSD(E)	3750

Non-cooled shelves are available for the following products

Product dimensions	Model	Length (mm)
	TVQ-EXC069WFVSD (SE)	1875
	TVQ-EXC089WFVSD (SE)	2500
	TVQ-EXC029WFVSD (SE)	3750

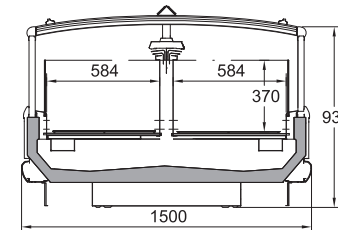

Width 1800 mm; Handrail height 935 mm
 Loaded depth 370 mm

Product dimensions	Model	Length (mm)
	TVQ-EXC069KFVSD(E)	1875
	TVQ-EXC089KFVSD(E)	2500
	TVQ-EXC029KFVSD(E)	3750

Non-cooled shelves are available for the following products

Product dimensions	Model	Length (mm)
	TVQ-EXC069KFVSD (SE)	1875
	TVQ-EXC089KFVSD (SE)	2500
	TVQ-EXC029KFVSD (SE)	3750

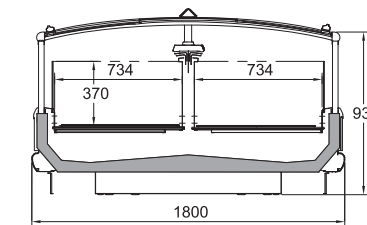

Width 2000 mm; Handrail height 935 mm
 Loaded depth 370 mm

Product dimensions	Model	Length (mm)
	TVQ-EXC069LFVSD(E)	1875
	TVQ-EXC089LFVSD(E)	2500
	TVQ-EXC029LFVSD(E)	3750

Non-cooled shelves are available for the following products

Product dimensions	Model	Length (mm)
	TVQ-EXC069LFVSD (SE)	1875
	TVQ-EXC089LFVSD (SE)	2500
	TVQ-EXC029LFVSD (SE)	3750

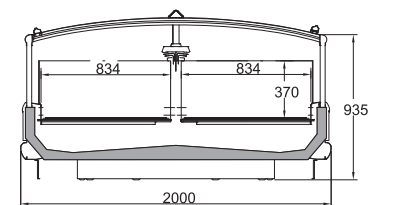

Width 1080 mm; Handrail height 930 mm
 Loaded depth 370 mm

Product dimensions	Model	Length (mm)
	TVQ-EXCCWFSD (E)	1500 (end case)
	TVQ-EXCCKFSD (E)	1800 (end case)
	TVQ-EXCCLFSD (E)	2000 (end case)

Non-cooled shelves are available for the following products

Product dimensions	Model	Length (mm)
	TVQ-EXCCWFSD (SE)	1500 (end case)
	TVQ-EXCCKFSD (SE)	1800 (end case)
	TVQ-EXCCLFSD (SE)	2000 (end case)

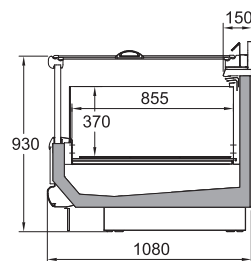

Width 1080 mm; Handrail height 935 mm
 Loaded depth 370 mm

Product dimensions	Model	Length (mm)
	TVQ-EXCCWFVSD(E)	1500(end case)
	TVQ-EXCCKFVSD(E)	1800(end case)
	TVQ-EXCCLFVSD(E)	2000(end case)

Non-cooled shelves are available for the following products

Product dimensions	Model	Length (mm)
	TVQ-EXCCWFVSD (SE)	1500(end case)
	TVQ-EXCCKFVSD (SE)	1800(end case)
	TVQ-EXCCLFVSD (SE)	2000(end case)

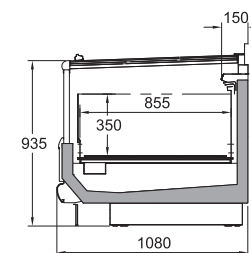

Select table for island freezer showcase models with a non-cooled shelf

	Non-cooled shelf model		
	Applicable display-case length	Width 350 mm	Width 500 mm
Open type	1875mm	TVQ-S6EXCWF (E)	TVQ-S6EXCKF (E)
	2500mm	TVQ-S8EXCWF (E)	TVQ-S8EXCKF (E)
	3750mm	TVQ-S2EXCWF (E)	TVQ-S2EXCKF (E)
Sliding sideways glass doors type	End case	-	-
	1875mm	TVQ-S6EXCWF(SE)	TVQ-S6EXCKF(SE)
	2500mm	TVQ-S8EXCWF(SE)	TVQ-S8EXCKF(SE)
Sliding up glass doors type	3750mm	TVQ-S2EXCWF(SE)	TVQ-S2EXCKF(SE)
	End case	-	-
	1875mm	TVQ-S6EXCWFVSD (E)	TVQ-S6EXCKFVSD (E)
Sliding up glass doors type	2500mm	TVQ-S8EXCWFVSD (E)	TVQ-S8EXCKFVSD (E)
	3750mm	TVQ-S2EXCWFVSD (E)	TVQ-S2EXCKFVSD (E)
	End case	-	-

Features and options for CZM

Features:

- All-metal exterior, soft lines, and a simple and rich texture
- Micro-computer digital-display temperature controller
- Optional non-cooled shelf for expanding the Multi-deck showcase
- Standardly equipped with price tag covers that are guaranteed to protect the tags and are easy for customers to view
- Refrigerant: R404A, and R407F
- Standardly interior LED lighting

Options:

- ESM speed-adjustable, energy-saving fan
- Interior dividing truss
- Installable glass door for the open-style refrigerated case
- Non-cooled shelf is available for some products
- Customizable exterior color
- Various side panels

• Optional interior LED lighting

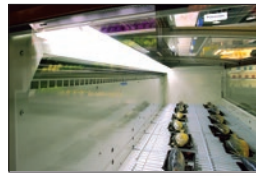

• Sealable display doors

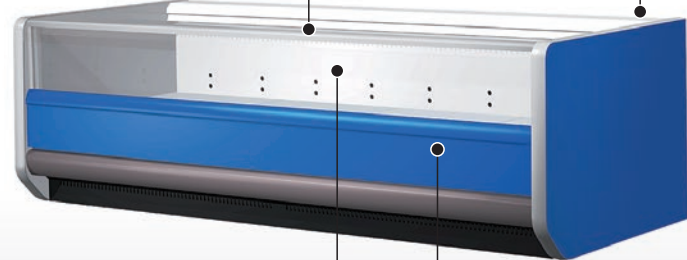

• Interior dividing truss



• ESM speed adjustable, energy-saving fan



* Unless otherwise noted, the pictured accessories are optional parts.

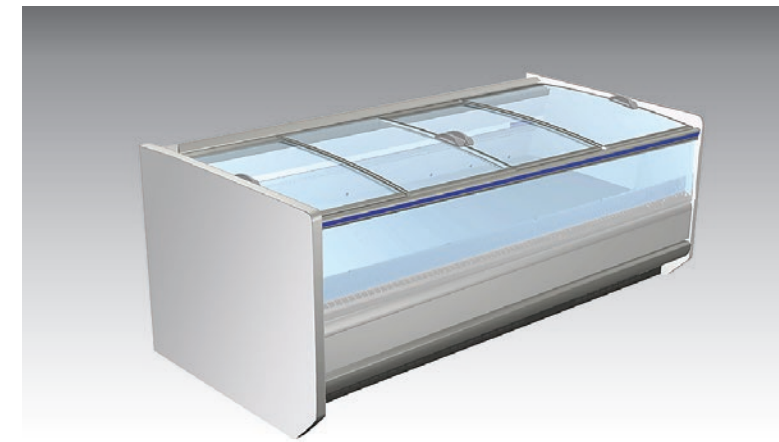

CZM-EXC087SD (E) CZM-EXC087SDB (E) Island freezer showcase Frozen food

-22°C to -18°C

- Remote type
- Sliding sideways glass doors



Width 1080 mm; Handrail height 830 mm

Loaded depth 260 mm

Product dimensions	Model	Length (mm)
	CZM-EXC067SD (E)	1875
	CZM-EXC087SD (E)	2500
	CZM-EXC027SD (E)	3750

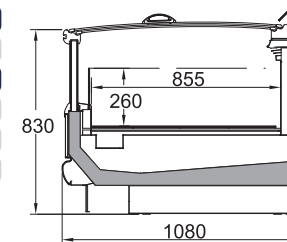

Width 1080 mm; Handrail height 930 mm

Loaded depth 370 mm

Product dimensions	Model	Length (mm)
	CZM-EXC067SDB (E)	1875
	CZM-EXC087SDB (E)	2500
	CZM-EXC027SDB (E)	3750
	CZM-EXCCSDB	2230(end case)

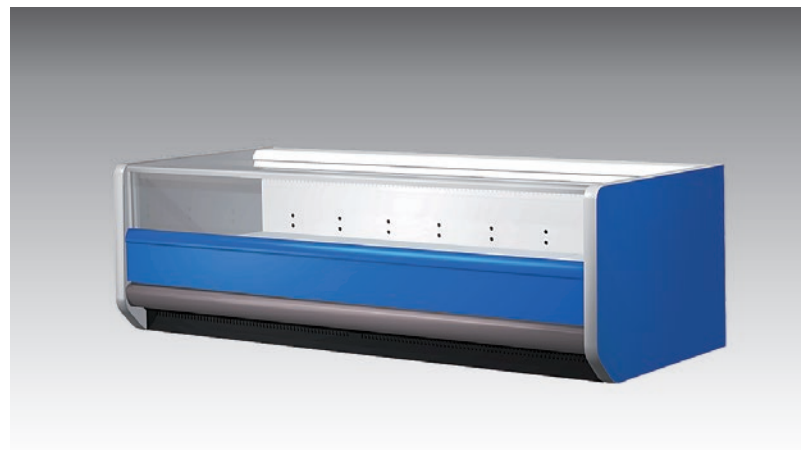
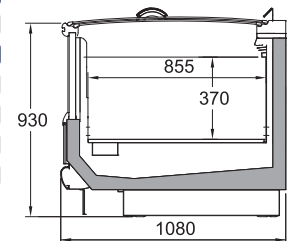

CZM-EXC087 (E) Island freezer showcase Frozen food

-22°C to -18°C

- Remote type

Width 1080 mm; Handrail height 790 mm

Loaded depth 260 mm

Product dimensions	Model	Length (mm)
	CZM-EXC067 (E)	1875
	CZM-EXC087 (E)	2500
	CZM-EXC027 (E)	3750
	CZM-EXCLO (E)	90° outer angle case

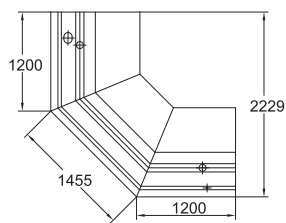
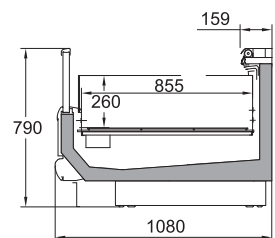

CZM-EXCLO

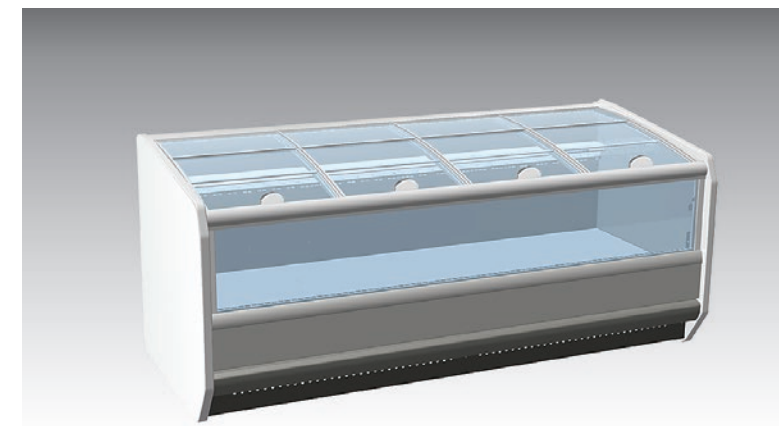

CZM-EXC089BFVSD (E) CZM-EXC889BFVSD (E) Island freezer showcase Frozen food

-22°C to -18°C

- Remote type
- Back-to-back installation available
- Non-cooled shelf installation available
- Sliding up glass doors



Width 1080 mm; Handrail height 935 mm

Loaded depth 370 mm

Product dimensions	Model	Length (mm)
	CZM-EXC069BFVSD (E)	1875
	CZM-EXC089BFVSD (E)	2500
	CZM-EXC029BFVSD (E)	3750

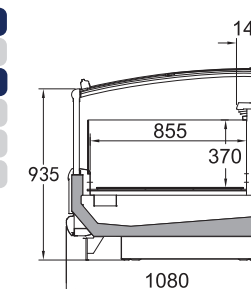

Width 880 mm; Handrail height 935 mm

Loaded depth 370 mm

Product dimensions	Model	Length (mm)
	CZM-EXC849BFVSD (E)	1250
	CZM-EXC869BFVSD (E)	1875
	CZM-EXC889BFVSD (E)	2500
	CZM-EXC829BFVSD (E)	3750
	CZM-EXCCBFVSD-1830 (E)	1830 (end case)

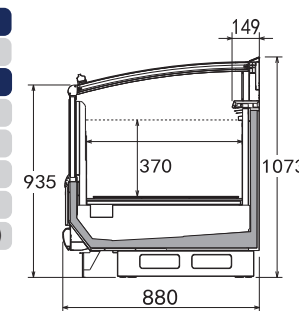

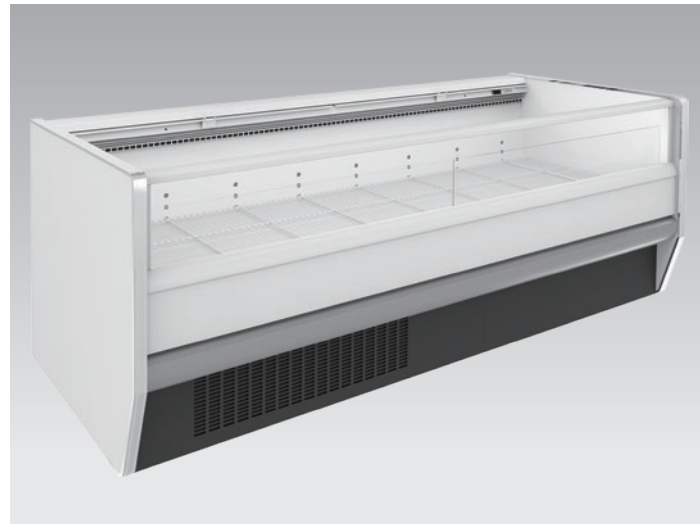

CZM-EXC087PI (E) Island freezer showcase Frozen food

-22°C to -18°C • Built-in type



Width 1080 mm; Height 935 mm Handrail height 260 mm					
Model	Length (mm)	Power consumption		Refrigerant	Defrost type
CZM-EXC067PI (E)T	1875	Operating 1700W(380V)	440.8W(220V)	R404A	Electric heating
		Defrosting 1790W(380V)	-		
CZM-EXC087PI (E)T	2500	Operating 2200W(380V)	566W(220V)		
		Defrosting 2380W(380V)	-		

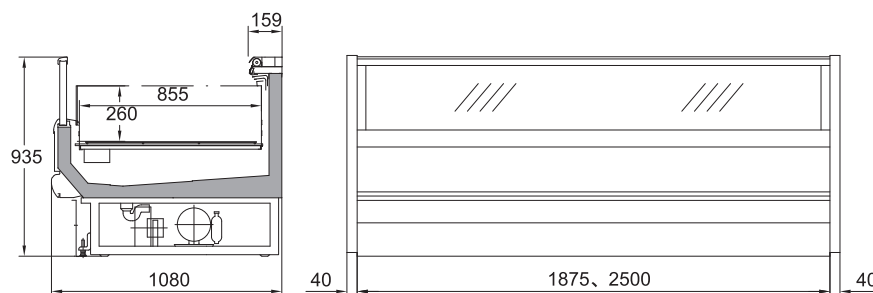

Select table for side-panel-model island freezer showcase (CZM series)

Model	Deluxe side panels	Regular side panels	
		Sprayed edges	Stainless-steel edges
CZM-EXC067 (E)/087 (E)/027 (E)	CZM-EXC07AEL/AER	CZM-EXC07EL-A/ER-A	CZM-EXC07EL-S/ER-S
CZM-EXC067SD (E)/087SD (E)/027SD (E)	CZM-EXC07AELSD/AERSD	CZM-EXC07ELSD-A/ERSD-A	CZM-EXC07ELSD-S/ERSD-S
CZM-EXC069BFVSD(E)/089BFVSD(E)/029BFVSD(E)	CZM-EXC09AELVSD/AERVSD	CZM-EXC09ELVSD-A/ERVSD-A	CZM-EXC09ELVSD-S/ERVSD-S
CZM-EXC849BFVSD(E)/869BFVSD(E)/889BFVSD(E)/829BFVSD(E)	CZM-EXC89AELVSD/AERVSD	CZM-EXC89ELVSD-A/ERVSD-A	CZM-EXC89ELVSD-S/ERVSD-S
CZM-EXC067PI (E)T/087PI (E)T	-	CZM-EXC07PIEL-A / PIER-A	CZM-EXC07PIEL-S / PIER-S

Select table for side-panel-model island freezer showcase (TEM series)

Model	Deluxe side panels	Regular side panels	
		Sprayed edges	Stainless-steel edges
TEM-EXC069P (E)T/089P (E)T	-	TEM-EXCPE1-A	TEM-EXCPE1-S



TEM-EXC089P (E) Island freezer showcase Frozen food

-22°C to -18°C • Built-in type

Width 1213 mm; Height 935 mm					
Model	Length (mm)	Power consumption		Refrigerant	Defrost type
TEM-EXC069P (E)T	1875	Operating 1700W(380V)	411.6W(220V)	R404A	Electric heating
		Defrosting 2295W(380V)	-		
TEM-EXC089P (E)T	2500	Operating 2200W(380V)	449.4W(220V)		
		Defrosting 3090W(380V)	-		

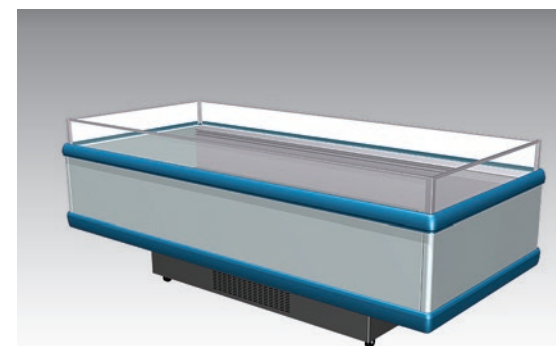
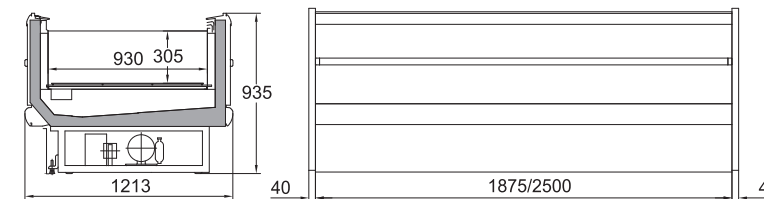

TEM-EXC088FAD (E) Island refrigerator/ freezer showcase

-18°C to -15°C

Fish & Meat

-2°C to 2°C • Built-in type
• 50Hz only
• Dual temperature
• Drain hole not required

Width 1100 mm; Height 930 mm Loaded depth 200 mm					
Model	Length (mm)	Power consumption		Refrigerant	Defrost type
TEM-EXC068FAL(E)	1800	Operating 1700W(380V)	258W(220V)	R404A	Electric heating
		Defrosting -	1800W(220V)		
TEM-EXC088FAL(E)	2400	Operating 1700W(380V)	324.7W(220V)		
		Defrosting 2380W(380V)	-		
TEM-EXC0681FAD(E)	1800	Operating 1100W(220V)	218W(220V)		
		Defrosting -	1800W(220V)		
TEM-EXC068FAD(E)	1800	Operating 1700W(380V)	218W(220V)		
		Defrosting -	1800W(220V)		
TEM-EXC088FAD(E)	2400	Operating 1700W(380V)	324.7W(220V)		
		Defrosting 2380W(380V)	-		

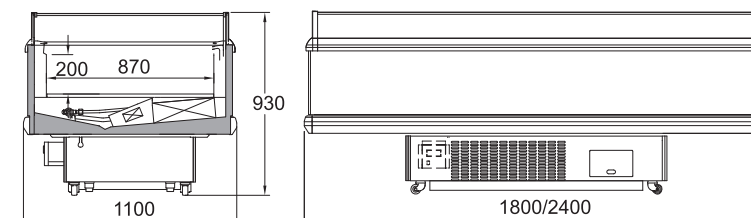

Features and options for FAM

Features:

- All-metal exterior, soft lines, and a simple and rich texture
- Front curved glass of main body with clear view
- Rear sliding door adopts ergonomic flat glass for easy operation
- Stainless-steel, impact-resistant working area that will not deform
- Micro-computer digital-display temperature controller
- High-efficient air curtain designed to guarantee temperature performance
- Refrigerant: R404A, and R407F
- Standardly LED lighting

Options:

- Weighing platform
- Toolbox
- Interior glass shelf for sealed products
- Exterior floor lighting
- Inclined truss
- Night curtain for open type showcase
- ESM speed-adjustable, energy-saving fan
- Customizable exterior color
- Various side panels

- Night curtain for open type showcase

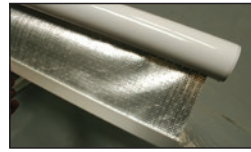

- Interior glass shelf for sealed products



- Exterior floor lighting

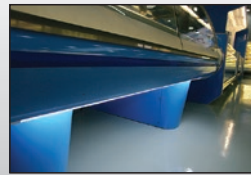

- LED lighting

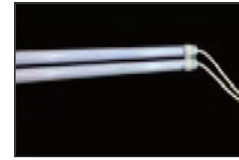

- Weighing platform

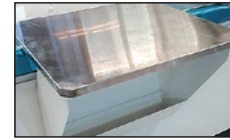

- Toolbox



- ESM speed adjustable, energy-saving fan



- Inclined truss

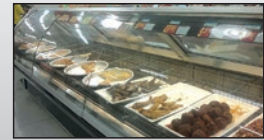

* Unless otherwise noted, the pictured accessories are optional parts.

FAM-BD8G (E)-L Serve over showcase Fish and meat

*Sliding door model available

-1°C to 5°C • Remote type • Flip-up curved glass

Width 1150 mm; Height 1210 mm

Working area height 845 mm

Model	Length (mm)
FAM-BD6G (E)-L	1875
FAM-BD8G (E)-L	2500
FAM-BD2G (E)-L	3750
FAM-BDLOG (E)-L	90° outer angle case
FAM-BDLIG (E)-L	90° inner angle case
FAM-BDVOG (E)-L	135° outer angle case
FAM-BDVIG (E)-L	135° inner angle case

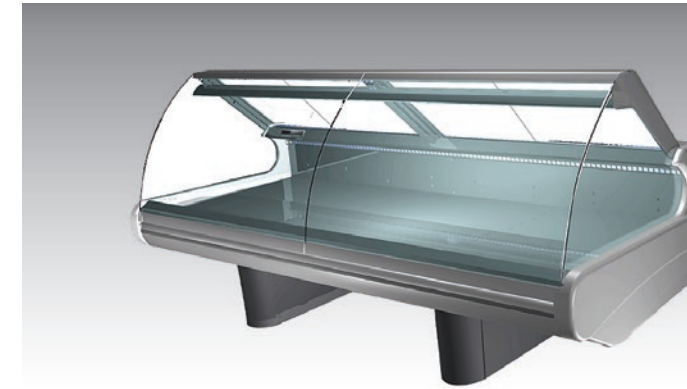

• Illustration of the angled display case:

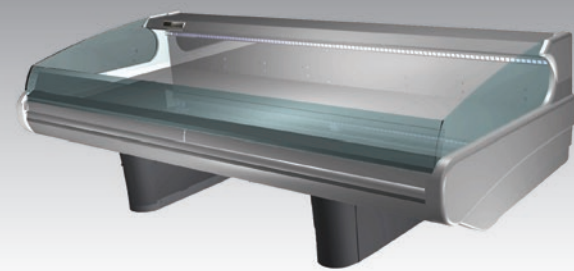
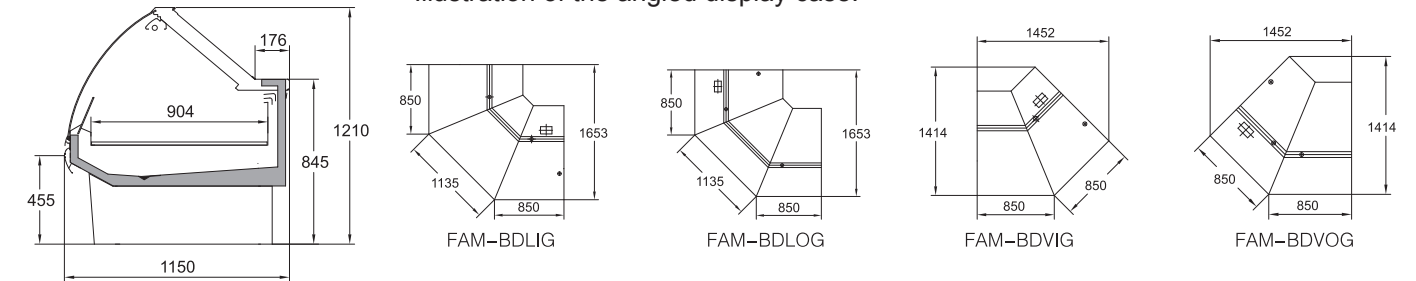

FAM-BD8 (E) FAM-BD8N (E) Serve over showcase Fish and meat

-1°C to 5°C • Remote type

Width 1150 mm; Height 845 mm

Working area height 845 mm

Model	Length (mm)
FAM-BD6 (E)	1875
FAM-BD8 (E)	2500
FAM-BD2 (E)	3750
FAM-BDLI (E)	90° inner angle case
FAM-BDLO (E)	90° outer angle case
FAM-BDVI (E)	135° inner angle case
FAM-BDVO (E)	135° outer angle case

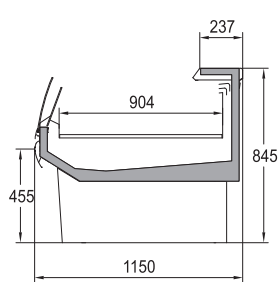

Width 1000 mm; Height 845 mm

Working area height 845 mm

Model	Length (mm)
FAM-BD6N (E)	1875
FAM-BD8N (E)	2500
FAM-BD2N (E)	3750

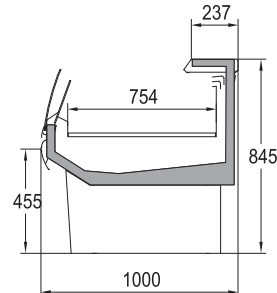

• Illustration of the angled display case:

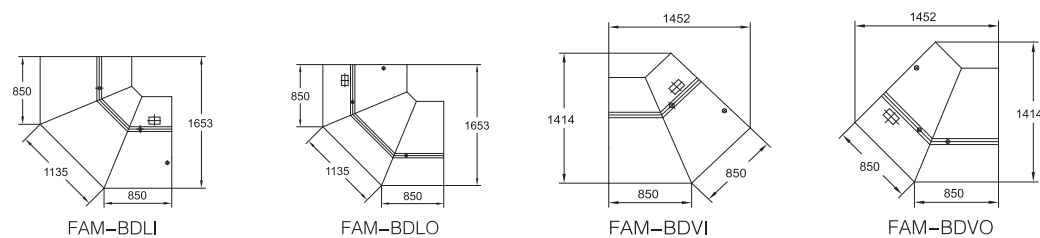

FAM-BD8GSD (E)-L FAM-BD8GSDN(E)-L Serve over showcase Fish and meat

-1°C to 5°C • Remote type • Sliding curved glass

Width 1150 mm; Height 1210 mm

Working area height 845 mm

Model	Length (mm)
FAM-BD6GSD (E)-L	1875
FAM-BD8GSD (E)-L	2500
FAM-BD2GSD (E)-L	3750
FAM-BDLOGSD (E)-L	90° outer angle case
FAM-BDLIGSD (E)-L	90° inner angle case
FAM-BDVOGSD (E)-L	135° outer angle case

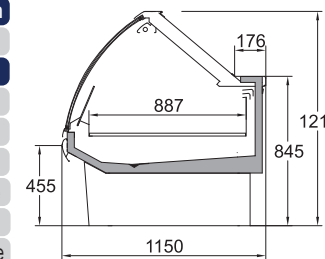

Width 1000 mm; Height 1210 mm

Working area height 845 mm

Model	Length (mm)
FAM-BD6GSDN (E)-L	1875
FAM-BD8GSDN (E)-L	2500
FAM-BD2GSDN (E)-L	3750
FAM-BDLOGSDN (E)-L	90° outer angle case

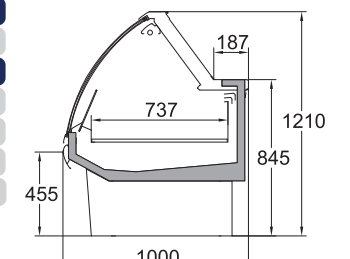

• Illustration of the angled display case:

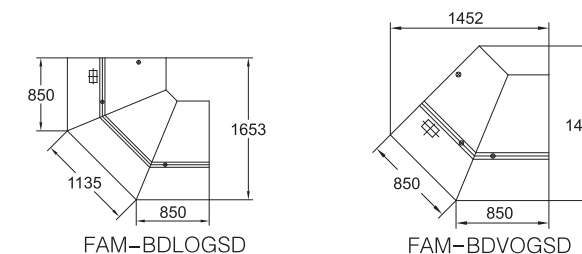

Serve over showcase

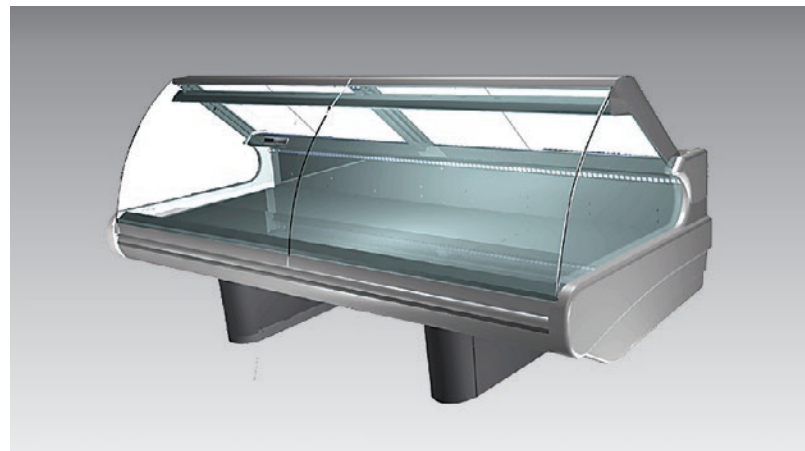

FAM-BD8GHW (E)
FAM-BD8GHWN(E)
FAM-BD8GHD(E)
FAM-BD8GHDN(E)

*Sliding door model available

Serve over showcase
Cooked food and processed goods

60°C to 65°C • Flip-up curved glass

Width 1150 mm; Height 1210 mm
Working area height 845 mm

Model	Length (mm)
Water-heat type	
FAM-BD6GHW (E)	1875
FAM-BD2GHW (E)	3750
Dry-heat type	
FAM-BD6GHD(E)	1875
FAM-BD8GHD (E)	2500
FAM-BD2GHD (E)	3750

Width 1150 mm; Height 1210 mm
Working area height 845 mm

Model	Length (mm)
Water-heat type	
FAM-BD8GHW (E)	2500
FAM-BDLOGHW (E)	90° outer angle case
Dry-heat type	
FAM-BDLOGHD (E)	90° outer angle case
FAM-BDVIGHD (E)	135° inner angle case

Width 1000 mm; Height 1210 mm
Working area height 845 mm

Model	Length (mm)
Water-heat type	
FAM-BD6GHWN (E)	1875
FAM-BD8GHWN (E)	2500
FAM-BD2GHWN (E)	3750
FAM-BDLOGHWN-T (E)	90° outer angle case
Dry-heat type	
FAM-BD6GHDN (E)	1875
FAM-BD8GHDN (E)	2500
FAM-BD2GHDN (E)	3750
FAM-BDLOGHDN-T (E)	90° outer angle case

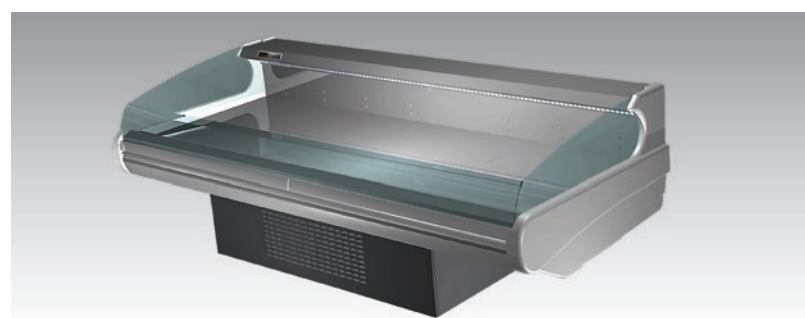
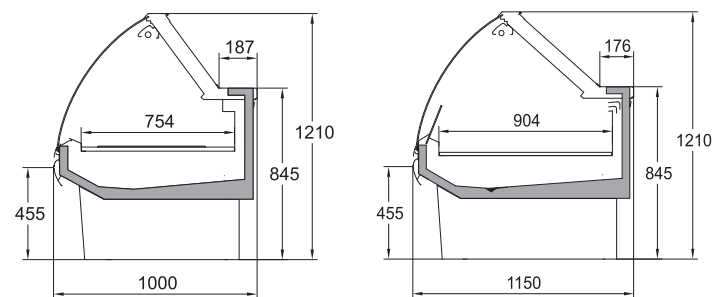

FAM-BD8PI (E)
Serve over showcase
Fish and meat

-1°C to 5°C • Built-in type • 50Hz only



Width 1150 mm; Height 845 mm
Working area height 845 mm

Model	Length (mm)	Power consumption	Refrigerant	Defrost type	
FAM-BD6PI (E)					
FAM-BD6PI (E)	1875	Operating	R404A	Electric heating	
		Defrosting			852W(220V)
		Lighting			500W(220V)
FAM-BD8PI (E)					
FAM-BD8PI (E)	2500	Operating	R404A	Electric heating	
		Defrosting			928W(220V)
		Lighting			750W(220V)
FAM-BD8PI (E)					
		Lighting	56 W (external, optional)		

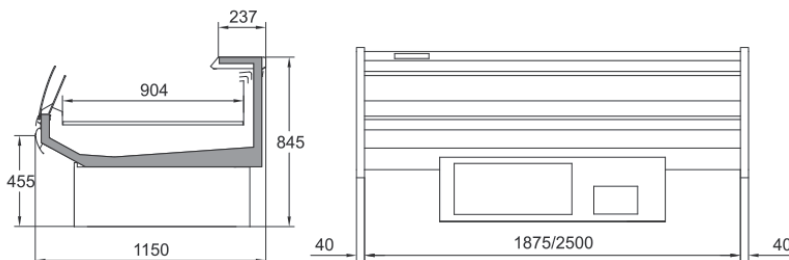

Serve over showcase

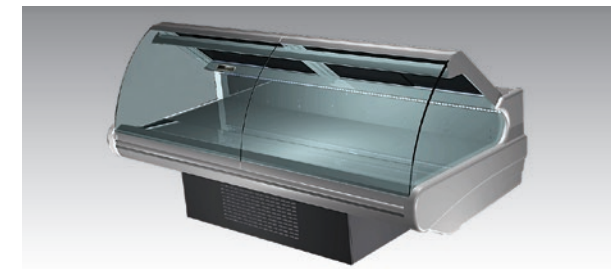

FAM-BD8GPI (E)-L
Serve over showcase
Fish and meat

-1°C to 5°C
 • Built-in type
 • 50Hz only



Width 1150 mm; Height 1210 mm
Working area height 845 mm

Model	Length (mm)	Power consumption	Refrigerant	Defrost type	
FAM-BD8GPI (E)-L					
FAM-BD8GPI (E)-L	1875	Operating	R404A	Electric heating	
		Defrosting			806W(220V)
		Lighting			500W(220V)
FAM-BD8GPI (E)-L					
FAM-BD8GPI (E)-L	2500	Operating	R404A	Electric heating	
		Defrosting			851W(220V)
		Lighting			750W(220V)
FAM-BD8GPI (E)-L					
		Lighting	56 W (external, optional)		

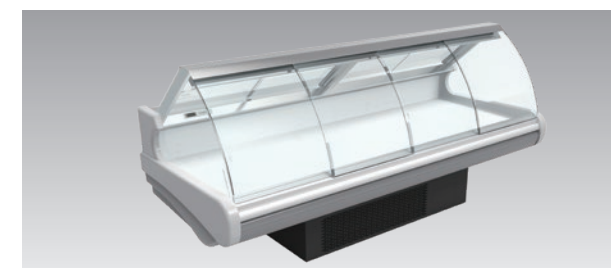
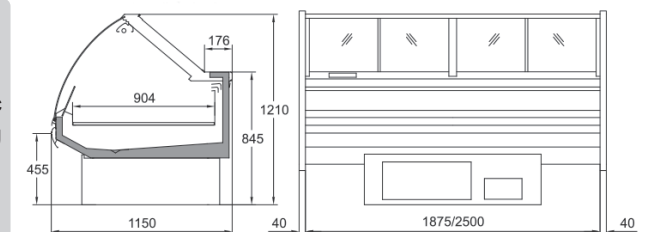

FAM-BD6GSDPI (E)-L
Serve over showcase
Fish and meat

-1°C to 5°C
 • Built-in type
 • Sliding curved glass

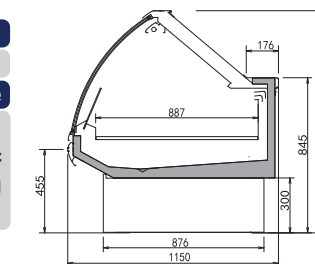

Width 1150 mm; Height 1210 mm
Working area height 845 mm

Model	Length (mm)	Power consumption	Refrigerant	Defrost type	
FAM-BD6GSDPI (E)-L					
FAM-BD6GSDPI (E)-L	1875	Operating	R404A	Electric heating	
		Defrosting			806W(220V)
		Lighting			500W(220V)
FAM-BD6GSDPI (E)-L					
		Lighting	60 W (external, optional)		

Select table for serve over showcase models (FAM series)

Model	Deluxe side panels	Regular side panels	
		Sprayed edges	Stainless steel edges
FAM-BD6 (E)/8 (E)/2 (E)		FAM-BDEL-A/ER-A	FAM-BDEL/ER
FAM-BDLI (E)/LO (E)/VI (E)/VO (E)	FAM-BDAEL/AER	FAM-BDEL-A/ER-A	FAM-BDEL/ER
FAM-BD6PI (E)/8PI (E)		FAM-BDEL-A/ER-A	FAM-BDEL/ER
FAM-BD6G (E)-L/8G (E)-L/2G (E)-L		FAM-BDGEL-A/ER-A	FAM-BDGEL/ER
FAM-BDLOG (E)-L/BDLIG(E)-L/BDVOG(E)-L/BDVIG(E)-L	FAM-BDGAEL/AER	FAM-BDGEL-A/ER-A	FAM-BDGEL/ER
FAM-BD6GHD (E)/8GHD (E)/2GHD (E)	-	FAM-BDGEL-A/ER-A	FAM-BDGEL/ER
FAM-BD6GHW (E)/8GHW(E)/2GHW (E)	-	FAM-BDGEL-A/ER-A	FAM-BDGEL/ER
FAM-BD6GPI (E)-L/8GPI (E)-L	FAM-BDGAEL/AER	FAM-BDGEL-A/ER-A	FAM-BDGEL/ER
FAM-BD6N(E)/8N(E)/2N(E)/BDLON-T(E)/BDLIN-T(E)	-	FAM-BDELN-A/ERN-A	FAM-BDELN/ERN
FAM-BD6GSD(E)-L/8GSD(E)-L/2GSD(E)-L	FAM-BDGAEL/AER	FAM-BDGEL-A/ER-A	FAM-BDGEL/ER
FAM-BD6GSDPI(E)-L	FAM-BDGAEL/AER	FAM-BDGEL-A/ER-A	FAM-BDGEL/ER
FAM-BDLOGSD(E)-L/BDLIGSD(E)-L/BDVOGSD(E)-L	FAM-BDGAEL/AER	FAM-BDGEL-A/ER-A	FAM-BDGEL/ER
FAM-BD6GSDN(E)-L/8GSDN(E)-L/2GSDN(E)-L/BDLOGSDN(E)-L	-	FAM-BDGELN-A/ERN-A	FAM-BDGELN/ERN
FAM-BDLOGHW(E)/BDLOGHD(E)/BDVIGHD(E)	-	FAM-BDGEL-A/ER-A	FAM-BDGEL/ER
FAM-BD6GHWN(E)/8GHWN(E)/2GHWN(E)/BDLOGHWN-T(E)	-	FAM-BDGELN-A/ERN-A	FAM-BDGELN/ERN
FAM-BD6GHDN(E)/8GHDN(E)/2GHDN(E)/BDLOGHDN-T(E)	-	FAM-BDGELN-A/ERN-A	FAM-BDGELN/ERN
FAM-IE6(E)/8(E)/2(E)	-	-	FAM-IEEL/ER
FAM-IELO(E)/IELOC(E)/IELI(E)/IELOCS(E)/IELICS(E)/IEVOC(S)/IEVIC(S)(E)	-	-	FAM-IEEL/ER
FAM-IE6G(E)/8G(E)/2G(E)	-	-	FAM-IEGEL/ER
FAM-IELOG(E)/IELOG-3L(E)/IELOCSG(E)/IELICSG(E)/IEVOC(SG)/IEVIC(SG)(E)	-	-	FAM-IEGEL/ER
FAM-IE6PI(E)	-	-	FAM-IEEL/ER
FAM-IE6GSDPI(E)	-	-	FAM-IEGAE/AER

Serve over showcase

Serve over showcase

Features and options for FAM

Features:

- All-metal exterior, soft lines, and a simple and rich texture
- Front curved glass of main body with clear view
- Rear sliding door adopts ergonomic flat glass for easy operation
- Stainless-steel, impact-resistant working area that will not deform
- Micro-computer digital-display temperature controller
- High-efficient air curtain designed to guarantee temperature performance
- Refrigerant: R404A, and R407F
- Standardly LED lighting

Options:

- Weighing platform
- Toolbox
- Interior glass shelf for sealed products
- Exterior floor lighting
- Inclined truss
- Night curtain for open type showcase
- ESM speed-adjustable, energy-saving fan
- Customizable exterior color
- Various side panels

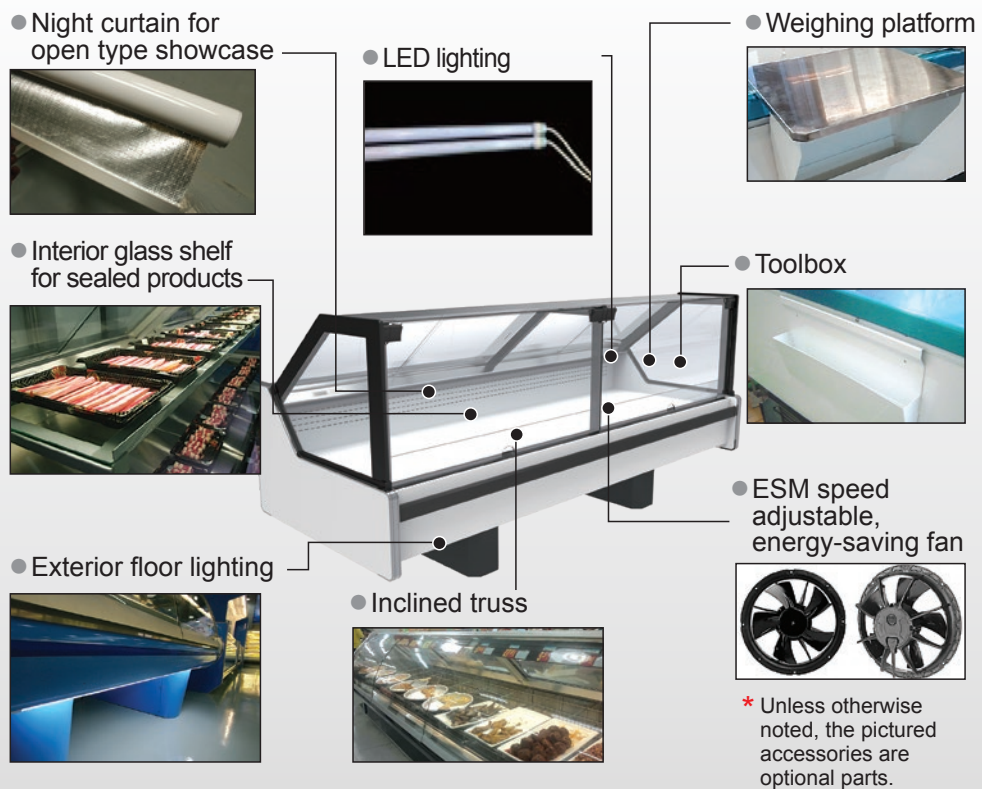

FAM-IE8G (E) Vertical glass Serve over showcase Fish & Meat

-1°C to 5°C
• Remote type

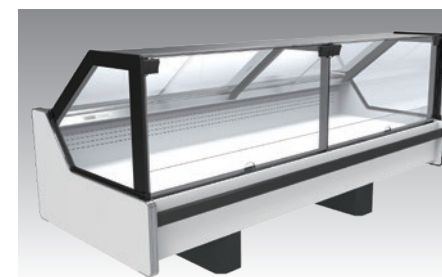

• Operating temperature for corner cases: 0°C to 6°C

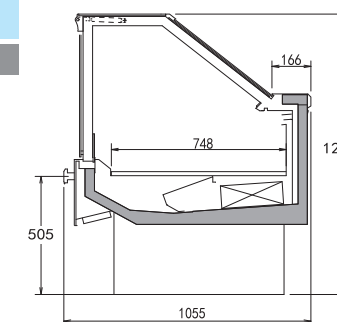

Width 1055 mm; Height 1200 mm
Handrail height 500 mm

Model	Length (mm)
FAM-IE6G (E)	1875
FAM-IE8G (E)	2500
FAM-IE2G (E)	3750
FAM-IELOGC (E)	Curved corner case
FAM-IELOG-3L (E)	Angled corner case

FAM-IE6PI (E) Serve over showcase Fish & Meat

-1°C to 5°C
• Built-in type

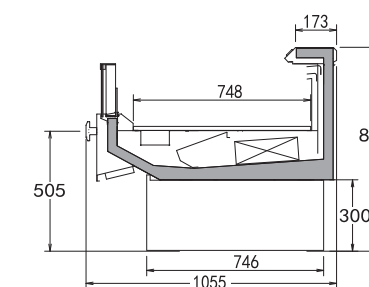

Width 1080 mm; Height 845 mm
Working area height 845 mm

Model	Length (mm)	Power consumption	Refrigerant	Defrost type
FAM-IE6PI (E)	1875	Operating: 851W(220V) Defrosting: 500W(220V)	R404A	Electric heating



FAM-IE8 (E) Serve over showcase Fish & Meat

-1°C to 5°C
• Remote type

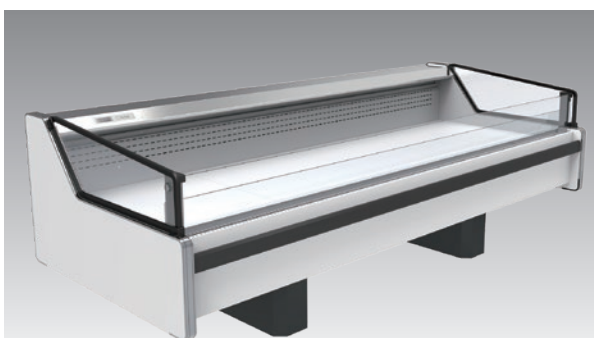

Width 1055 mm; Height 875 mm

Model	Length (mm)
FAM-IE6 (E)	1875
FAM-IE8 (E)	2500
FAM-IE2 (E)	3750
FAM-IELO (E)	90° outer angle case
FAM-IELOC (E)	90° outer angle case
FAM-IEVOCS (E)	135° outer angle case

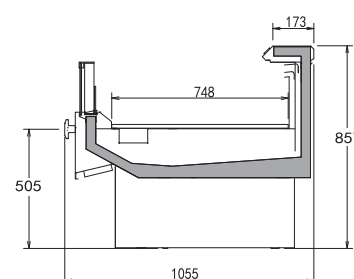

• Illustration of the corner case:

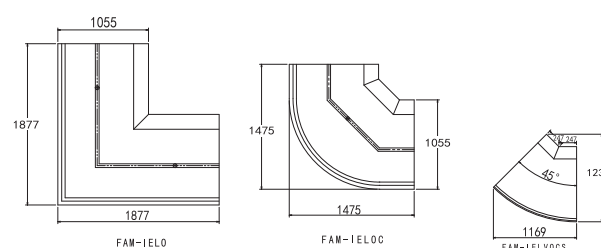

FAM-IE6GSDPI(E) Vertical glass Serve over showcase Fish & Meat

-1°C to 5°C
• Built-in type

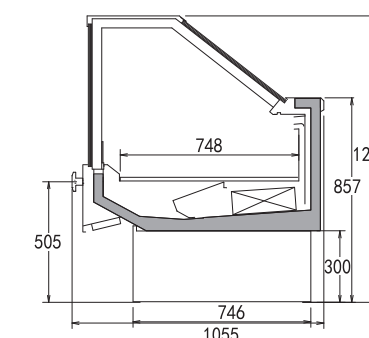
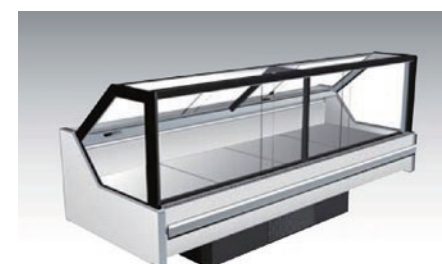

Width 1055 mm; Height 845 mm
Working area height 845 mm

Model	Length (mm)	Power consumption	Refrigerant	Defrost type
FAM-IE6GSDPI (E)	1875	Operating: 857W(220V) Defrosting: -	R404A	Electric heating

Features and options for CSM

Features:

- All-metal exterior, soft lines, and a simple and rich texture
- Micro-computer digital-display temperature controller
- Standardly equipped with internal LED lighting
- Standardly equipped with price tag covers that are guaranteed to protect the tags and are easy for customers to view
- Refrigerant: R404A, and R407F

Options:

- ESM speed-adjustable, energy-saving fan
- Mirror
- Anti-reflective shelves
- Customizable exterior color
- Various side panels

• Mirror



• Interior LED lighting



• Anti-reflective shelf



• ESM speed adjustable, energy-saving fan

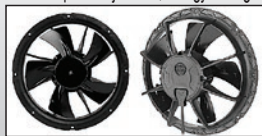

* Unless otherwise noted, the pictured accessories are optional parts.

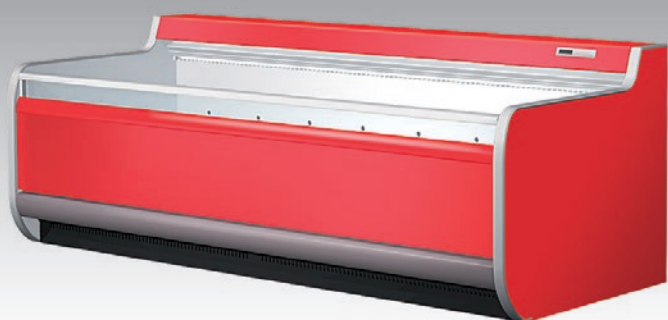
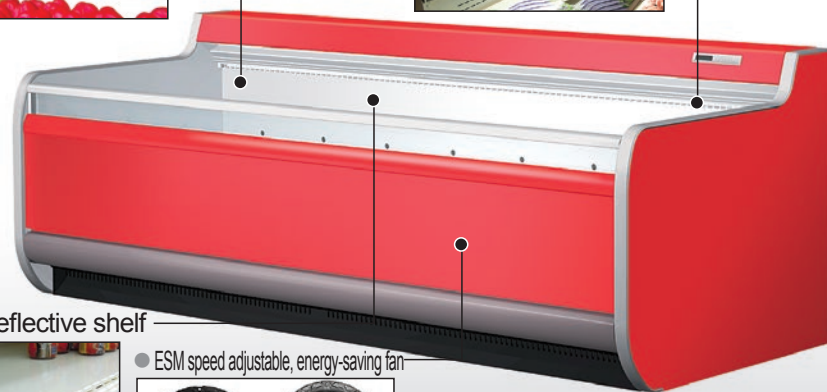

CSM-EXC087 (E)-L Island showcase Fish and Meat

-2°C to 2°C • Remote type

Width 1080 mm; Height 930 mm

Handrail height 750 mm; Loaded depth 216 mm

Model	Length (mm)
CSM-EXC067(E)-L	1875
CSM-EXC087(E)-L	2500
CSM-EXC027(E)-L	3750

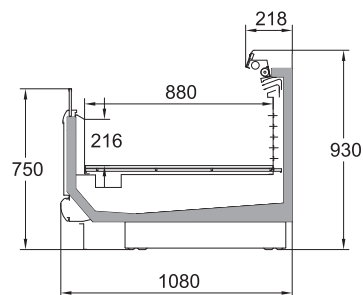

CSM-EXC1087M (E)-L Island showcase Fish and Meat

-2°C to 2°C • Remote type

Width 1080 mm; Height 1050 mm

Handrail height 750 mm; Loaded depth 216 mm

Model	Length (mm)
CSM-EXC1067M (E)-L	1875
CSM-EXC1087M (E)-L	2500
CSM-EXC1027M (E)-L	3750

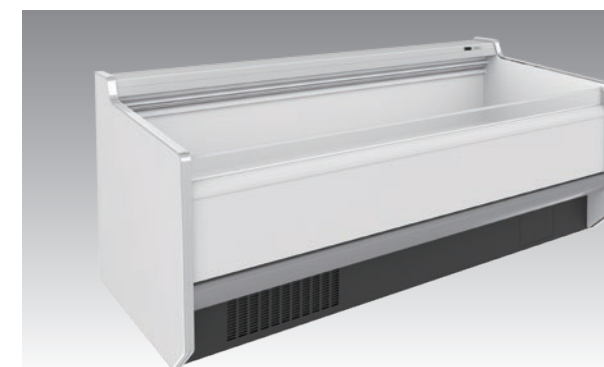
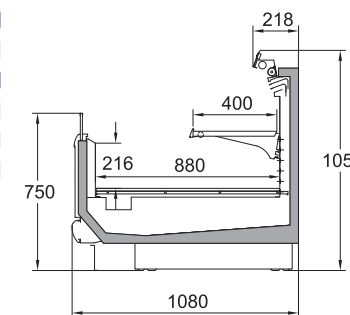

CSM-EXC087PI (E)-L Island showcase Fish and Meat

-2°C to 2°C • Built-in type

Width 1080 mm; Height 1075 mm

Working area height 895 mm

Product dimensions	Model	Length (mm)	Power consumption		Refrigerant	Defrost type
			Operating	Defrosting		
CSM-EXC067PI (E)-L	1875	Operating	854W(220V)	R404A	Electric heating	
		Defrosting	930W(220V)			
		Lighting	20 W			
CSM-EXC087PI (E)-L	2500	Operating	890.4W(220V)	R404A	Electric heating	
		Defrosting	1240W(220V)			
		Lighting	26 W			

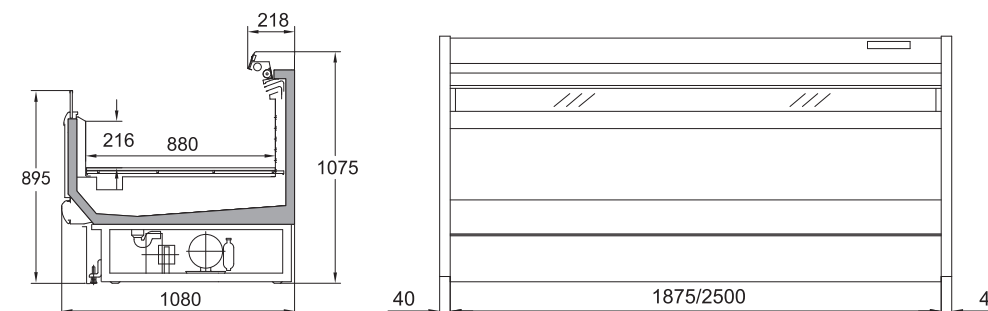

Select table for island type showcase models (CSM series)

Model	Deluxe side panels	Regular side panels	
		Sprayed edges	Stainless steel edges
CSM-EXC067(E)-L/087(E)-L/027(E)-L	-	CSM-EXC07EL-A/ER-A	CSM-EXC07EL-S/ER-S
CSM-EXC1067M (E)-L/1087M (E)-L/1027M (E)-L	-	CSM-EXC107EL-A/ER-A	CSM-EXC107EL-S/ER-S
CSM-EXC067PI(E)-L/087PI(E)-L	-	CSM-EXC07PIEL-A/ER-A	CSM-EXC07PIEL-S/ER-S

Features and options for LDG

Features:

- Clear and elegant curved glass for a stylish external appearance
- Compact size with a large display space for an optimized shopping experience
- Adopts advanced Hot gas defrosting technology for improved energy savings
- Various possible combinations with a flexible layout for upgrading a store
- Uses a wire-tube condenser to avoid regular cleaning and simplify maintenance
- Standardly equipped with internal separators for ease of use
- A choice among various interior lighting products in the standard configuration
- Refrigerant: R404A

Options:

- Non-cooled shelf
- Exhaust plate at the connection
- Top price-tag covers
- Display skirt
- Customizable exterior color

- Non-cooled shelf



- Exhaust plate at the connection and price-tag covers

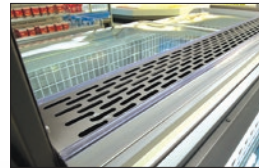

- Highly efficient units, cleaning free, and low maintenance



- Standardly equipped with internal separators

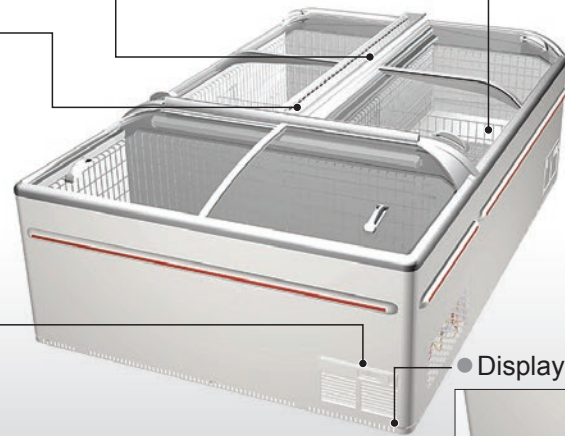

- Display skirt

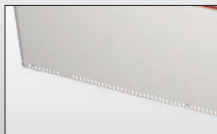

* Unless otherwise noted, the pictured accessories are optional parts.



LDG-189LVC(E)-W Island freezer showcase Frozen food

- -22°C to -18°C
- Built-in type
- Drain hole not required
- Standardly equipped with internal lighting

		Width 1018 mm; Height 931 mm			
		Handrail height 820 mm			
Product dimension	Model	Length (mm)	Power consumption	Refrigerant	Defrost type
	LDG-189LVC(E)-W	1805	Operation	R404A	Hot gas defrost
			Defrost		
	LDG-219LVC(E)-W	2105	Operation	R404A	Hot gas defrost
			Defrost		
	LDG-219ULVC(E)-W	2150	Operation	R404A	Hot gas defrost
			Defrost		

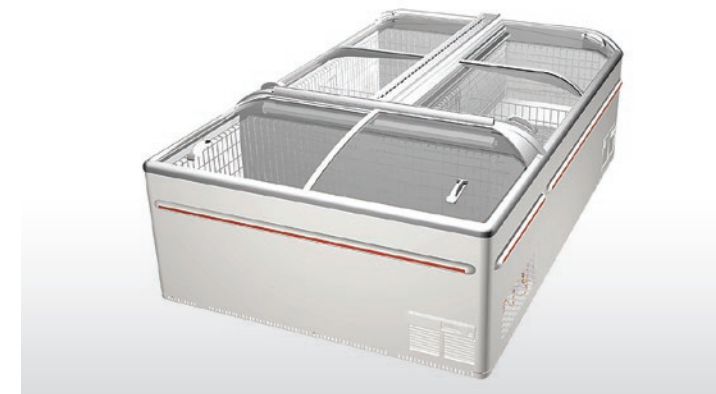
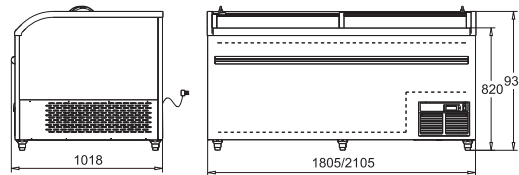

LDG-188LVC(E)-W Island freezer showcase Frozen food

- -22°C to -18°C
- Built-in type
- Drain hole not required

		Width 868mm; Height 890mm			
		Handrail height 780mm			
Product dimension	Model	Length (mm)	Power Consumption	Refrigerant	Defrost type
	LDG-128LVC(E)-W	1205	Operation	R404A	Hot gas defrost
			Defrost		
	LDG-158LVC(E)-W	1505	Operation	R404A	Hot gas defrost
			Defrost		
	LDG-188LVC(E)-W	1805	Operation	R404A	Hot gas defrost
			Defrost		
	LDG-218LVC(E)-W	2105	Operation	R404A	Hot gas defrost
			Defrost		
	LDG-188LVC(E)-W	1805	Operation	R404A	Hot gas defrost
			Defrost		
	LDG-218LVC(E)-W	2105	Operation	R404A	Hot gas defrost
			Defrost		
	LDG-218LVC(E)-W	2105	Operation	R404A	Hot gas defrost
			Defrost		
	LDG-218LVC(E)-W	2105	Operation	R404A	Hot gas defrost
			Defrost		
	LDG-218LVC(E)-W	2105	Operation	R404A	Hot gas defrost
			Defrost		
	LDG-218LVC(E)-W	2105	Operation	R404A	Hot gas defrost
			Defrost		
	LDG-218LVC(E)-W	2105	Operation	R404A	Hot gas defrost
			Defrost		
	LDG-218LVC(E)-W	2105	Operation	R404A	Hot gas defrost
			Defrost		
	LDG-218LVC(E)-W	2105	Operation	R404A	Hot gas defrost
			Defrost		
	LDG-218LVC(E)-W	2105	Operation	R404A	Hot gas defrost
			Defrost		
	LDG-218LVC(E)-W	2105	Operation	R404A	Hot gas defrost
			Defrost		
	LDG-218LVC(E)-W	2105	Operation	R404A	Hot gas defrost
			Defrost		
	LDG-218LVC(E)-W	2105	Operation	R404A	Hot gas defrost
			Defrost		
	LDG-218LVC(E)-W	2105	Operation	R404A	Hot gas defrost
			Defrost		
	LDG-218LVC(E)-W	2105	Operation	R404A	Hot gas defrost
			Defrost		
	LDG-218LVC(E)-W	2105	Operation	R404A	Hot gas defrost
			Defrost		
	LDG-218LVC(E)-W	2105	Operation	R404A	Hot gas defrost
			Defrost		
	LDG-218LVC(E)-W	2105	Operation	R404A	Hot gas defrost
			Defrost		
	LDG-218LVC(E)-W	2105	Operation	R404A	Hot gas defrost
			Defrost		
	LDG-218LVC(E)-W	2105	Operation	R404A	Hot gas defrost
			Defrost		
	LDG-218LVC(E)-W	2105	Operation	R404A	Hot gas defrost
			Defrost		
	LDG-218LVC(E)-W	2105	Operation	R404A	Hot gas defrost
			Defrost		
	LDG-218LVC(E)-W	2105	Operation	R404A	Hot gas defrost
			Defrost		
	LDG-218LVC(E)-W	2105	Operation	R404A	Hot gas defrost
			Defrost		
	LDG-218LVC(E)-W	2105	Operation	R404A	Hot gas defrost
			Defrost		
	LDG-218LVC(E)-W	2105	Operation	R404A	Hot gas defrost
			Defrost		
	LDG-218LVC(E)-W	2105	Operation	R404A	Hot gas defrost
			Defrost		
	LDG-218LVC(E)-W	2105	Operation	R404A	Hot gas defrost
			Defrost		
	LDG-218LVC(E)-W	2105	Operation	R404A	Hot gas defrost
			Defrost		
	LDG-218LVC(E)-W	2105	Operation	R404A	Hot gas defrost
			Defrost		
	LDG-218LVC(E)-W	2105	Operation	R404A	Hot gas defrost
			Defrost		
	LDG-218LVC(E)-W	2105	Operation	R404A	Hot gas defrost
			Defrost		
	LDG-218LVC(E)-W	2105	Operation	R404A	Hot gas defrost
			Defrost		
	LDG-218LVC(E)-W	2105	Operation	R404A	Hot gas defrost
			Defrost		
	LDG-218LVC(E)-W	2105	Operation	R404A	Hot gas defrost
			Defrost		
	LDG-218LVC(E)-W	2105	Operation	R404A	Hot gas defrost
			Defrost		
	LDG-218LVC(E)-W	2105	Operation	R404A	Hot gas defrost
			Defrost		
	LDG-218LVC(E)-W	2105	Operation	R404A	Hot gas defrost
			Defrost		
	LDG-218LVC(E)-W	2105	Operation	R404A	Hot gas defrost
			Defrost		
	LDG-218LVC(E)-W	2105	Operation	R404A	Hot gas defrost
			Defrost		
	LDG-218LVC(E)-W	2105	Operation	R404A	Hot gas defrost
			Defrost		
	LDG-218LVC(E)-W	2105	Operation	R404A	Hot gas defrost
			Defrost		
	LDG-218LVC(E)-W	2105	Operation	R404A	Hot gas defrost
			Defrost		
	LDG-218LVC(E)-W	2105	Operation	R404A	Hot gas defrost
			Defrost		
	LDG-218LVC(E)-W	2105	Operation	R404A	Hot gas defrost
			Defrost		
	LDG-218LVC(E)-W	2105	Operation	R404A	Hot gas defrost
			Defrost		
	LDG-218LVC(E)-W	2105	Operation	R404A	Hot gas defrost
			Defrost		
	LDG-218LVC(E)-W	2105	Operation	R404A	Hot gas defrost
			Defrost		
	LDG-218LVC(E)-W	2105	Operation	R404A	Hot gas defrost
			Defrost		
	LDG-218LVC(E)-W	2105	Operation	R404A	Hot gas defrost
			Defrost		
	LDG-218LVC(E)-W	2105	Operation	R404A	Hot gas defrost
			Defrost		
	LDG-218LVC(E)-W	2105	Operation	R404A	Hot gas defrost
			Defrost		
	LDG-218LVC(E)-W	2105	Operation	R404A	Hot gas defrost
			Defrost		
	LDG-218LVC(E)-W	2105	Operation	R404A	Hot gas defrost
			Defrost		
	LDG-218LVC(E)-W	2105	Operation	R404A	Hot gas defrost
			Defrost		
	LDG-218LVC(E)-W	2105	Operation	R404A	Hot gas defrost
			Defrost		
	LDG-218LVC(E)-W	2105	Operation	R404A	Hot gas defrost
			Defrost		
	LDG-218LVC(E)-W	2105	Operation	R404A	Hot gas defrost
			Defrost		
	LDG-218LVC(E)-W	2105	Operation	R404A	Hot gas defrost
			Defrost		
	LDG-218LVC(E)-W	2105	Operation	R404A	Hot gas defrost
			Defrost		
	LDG-218LVC(E)-W	2105	Operation	R404A	Hot gas defrost
			Defrost		
	LDG-218LVC(E)-W	2105	Operation	R404A	Hot gas defrost
			Defrost		
	LDG-218LVC(E)-W	2105	Operation	R404A	Hot gas defrost
			Defrost		
	LDG-218LVC(E)-W	2105	Operation	R404A	Hot gas defrost
			Defrost		
	LDG-218LVC(E)-W	2105	Operation	R404A	Hot gas defrost
			Defrost		
	LDG-218LVC(E)-W	2105	Operation	R404A	Hot gas defrost
			Defrost		
	LDG-218LVC(E)-W	2105	Operation	R404A	Hot gas defrost
			Defrost		
	LDG-218LVC(E)-W	2105	Operation	R404A	Hot gas defrost
			Defrost		
	LDG-218LVC(E)-W	2105	Operation	R404A	Hot gas defrost
			Defrost		
	LDG-218LVC(E)-W	2105	Operation	R404A	Hot gas defrost
			Defrost		
	LDG-218LVC(E)-W	2105	Operation	R404A	Hot gas defrost
			Defrost		
	LDG-218LVC(E)-W	2105	Operation	R404A	Hot gas defrost
			Defrost		
	LDG-218LVC(E)-W	2105	Operation	R404A	Hot gas defrost
			Defrost		
	LDG-218LVC(E)-W	2105	Operation	R404A	Hot gas defrost
			Defrost		
	LDG-218LVC(E)-W	2105	Operation	R404A	Hot gas defrost
			Defrost		
	LDG-218LVC(E)-W	2105	Operation	R404A	Hot gas defrost
			Defrost		
	LDG-218LVC(E)-W	2105	Operation	R404A	Hot gas defrost
			Defrost		
	LDG-218LVC(E)-W	2105	Operation	R404A	Hot gas defrost
			Defrost		
	LDG-218LVC(E)-W	2105	Operation	R404A	Hot gas defrost
			Defrost		
	LDG-218LVC(E)-W	2105	Operation	R404A	Hot gas defrost
			Defrost		
	LDG-218LVC(E)-W	2105	Operation	R404A	Hot gas defrost
			Defrost		
	LDG-218LVC(E)-W	2105	Operation	R404A	Hot gas defrost
			Defrost		
	LDG-218LVC(E)-W	2105	Operation	R404A	Hot gas defrost
			Defrost		
	LDG-218LVC(E)-W	2105	Operation	R404A	Hot gas defrost
			Defrost		
	LDG-218LVC(E)-W	2105	Operation	R404A	Hot gas defrost
			Defrost		
	LDG-218LVC(E)-W	2105	Operation	R404A	Hot gas defrost
			Defrost		
	LDG-218LVC(E)-W				

Cooling coil

Features:

- Embossed aluminum panel casing; simple design, lightweight, and corrosion resistant
- The blades have a rippled design to increase surface area and thereby increase refrigeration capacity
- A built-in junction box for simple and safe wiring
- Uses a low-noise motor and fan blades
- Can maintain an appropriate temperature in the cold storage, preventing internal moisture loss in the stored goods (Except CC-CTL series)
- Uses an inclined drain tray, which quickly discharges water without affecting the level installation of the air cooler
- The side panels fold for easy opening, facilitating installation (Except CC-CTL series)
- The expansion valve is installed within the air cooler. This improves the appearance and safety of the unit, while also preventing condensed water from dripping on the goods.
- The bottom cover is easy to open and facilitates maintenance and repair
- Draining direction is adjustable
- Low wind speed, reduce weight loss and water loss. (CC-CTL series)
- Inclined design, making the product compact (CC-CTL series)

Options:

- Sprayed casing
- Stainless-steel casing
- For use in special environments, the corrosion resistance of the entire unit can be optimized

CC-CV series

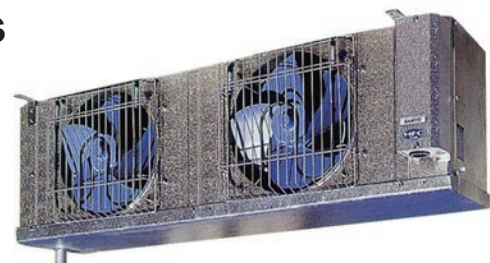

CC-CM series

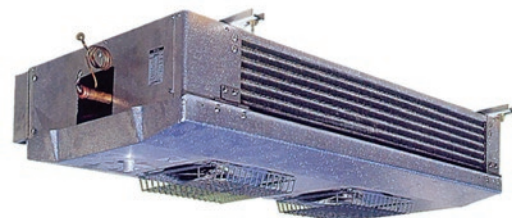

CC-CD series



CC-CTL series



Cooling coil

Model	Applicable temp	Refrigeration capacity			Cooling area (m ²)	Blast capacity (m ³ /min)	Power consumption 3φ, 380V, 50Hz		Weight (kg)
		TD5°C (W)	TD7°C (W)	TD10°C (W)			Operation (kW)	Defrost (kW)	
							(kW)	(kW)	
CC-CV3000(E)	Above 3°C	1,510	2,100	3,010	8.67	29.0	0.12	0.12	22
CC-CV6000(E)		3,120	4,360	6,230	17.89	57.0	0.23	0.23	36
CC-CV9000(E)		4,660	6,520	9,330	27.06	85.0	0.35	0.35	53
CC-CV3000H(E)	-10 - 3°C	1,510	2,100	3,010	8.67	29.0	0.12	1.48	24
CC-CV6000H(E)		3,120	4,360	6,230	17.89	57.0	0.23	2.70	39
CC-CV9000H(E)		4,660	6,520	9,330	27.06	85.0	0.35	3.90	57
CC-CV2000FH(E)	-35 - -10°C	1,080	1,510	2,160	5.85	30.0	0.12	2.00	22
CC-CV4000FH(E)		2,240	3,140	4,490	12.02	59.0	0.23	3.70	38
CC-CV6000FH(E)		3,360	4,710	6,720	18.20	88.0	0.35	5.25	55
CC-CM2000(E)	Above 3°C	1,050	1,450	2,080	10.21	15.6	0.08	0.08	27
CC-CM4000(E)		2,120	2,950	4,220	20.73	31.2	0.15	0.15	39
CC-CM6000(E)		3,170	4,440	6,340	31.11	46.8	0.22	0.22	59
CC-CM8000(E)		4,230	5,930	8,470	41.55	62.4	0.30	0.30	75
CC-CM10000(E)	-10 - 3°C	5,280	7,500	10,600	51.94	78.0	0.32	0.30	98
CC-CM2000H(E)		1,050	1,450	2,080	10.21	15.6	0.11	0.89	29
CC-CM4000H(E)		2,120	2,950	4,220	20.73	31.2	0.18	1.59	42
CC-CM6000H(E)		3,170	4,440	6,340	31.11	46.8	0.25	2.26	63
CC-CM8000H(E)	Above 3°C	4,230	5,930	8,470	41.55	62.4	0.32	2.68	80
CC-CM10000H(E)		5,280	7,500	10,600	51.94	78.0	0.34	3.03	103
CC-CD9000(E)		5,470	7,640	10,920	31.19	72.0	0.40	0.40	48
CC-CD14000(E)		8,200	11,470	16,380	47.14	108.0	0.60	0.60	65
CC-CD19000(E)	-10 - 3°C	10,950	15,340	21,910	63.28	144.0	0.80	0.80	87
CC-CD24000(E)		13,690	19,150	27,360	79.23	180.0	1.00	1.00	113
CC-CD9000H(E)		5,470	7,640	10,920	31.19	72.0	0.40	3.00	52
CC-CD14000H(E)		8,200	11,470	16,380	47.14	108.0	0.60	4.30	72
CC-CD19000H(E)	-40 - -10°C	10,950	15,340	21,910	63.28	144.0	0.80	5.40	97
CC-CD24000H(E)		13,690	19,150	27,360	79.23	180.0	1.00	6.80	126
CC-CD4000LH(E)		2,140	2,990	4,270	10.55	49.0	0.15	3.35	36
CC-CD6000LH(E)		3,430	4,790	6,850	14.68	82.0	0.40	4.40	50
CC-CD9000LH(E)	Above 3°C	5,120	7,160	10,230	22.17	123.0	0.60	6.35	70
CC-CD12000LH(E)		6,880	9,630	13,760	29.76	164.0	0.80	7.90	92
CC-CD15000LH(E)		8,590	12,030	17,190	37.24	205.0	1.00	9.95	119

Model	Applicable temp	Refrigeration capacity	Cooling area (m ²)	Blast capacity (m ³ /min)	Power consumption 1φ, 220V, 50Hz		Weight (kg)
		TD8°C (W)			Operation (kW)	Defrost (kW)	
					(kW)		
CC-CTL2500(E)	3°C - 10°C	2,478	13.05	20.6	0.14	0.14	25
CC-CTL3000(E)		3,086	16.48	25.7	0.17	0.17	30

Supermarket Showcase EXC Series Technical Data

Supermarket Showcase EXC Series Technical Data

Model No.	Temp Range	Req Cooling Capacity		Fan Motor	Display Area (m²)	3-Phase 380V		1-Phase 220V (50Hz)							
		25°C 60% (W)	27°C 70% (W)			Defrost Heater		Fan Motor		Light		Anti-dew heater +door frame heater		Total	
						W	A	W	A	W	A	W	A	W	A
Fish & Meat Multi-deck showcase <Evaporating temperature -10°C>															
FPW-EXC063(E)-L	0-4	2480	2920	12W*3	4.94	1280	3.37	75	0.33	232	1.05	32.8	0.15	339.8	1.53
FPW-EXC083(E)-L		3300	3900	12W*3	6.59	1610	4.24	85.5	0.39	296	1.34	43.8	0.2	425.3	1.93
FPW-EXC023(E)-L		4950	5840	12W*5	9.88	2260	5.95	135.5	0.61	445	2.03	66.5	0.3	647	2.94
FPW-EXC030(E)-L		2890	3410	8W*3	5.76	1445	3.8	85.5	0.39	261	1.18	39.4	0.18	385.9	1.75
FPW-EXC084(E)-L	-2-2	2180	2570	12W*3	4.94	1280	3.37	75	0.33	232	1.05	32.8	0.15	339.8	1.53
FPW-EXC084(E)-L		2900	3420	12W*3	6.59	1610	4.24	85.5	0.39	296	1.34	43.8	0.2	425.3	1.93
FPW-EXC024(E)-L		4350	5130	12W*5	9.88	2260	5.95	135.5	0.61	445	2.03	66.5	0.3	647	2.94
FPW-EXC040(E)-L		2540	3000	8W*3	5.76	1445	3.8	85.5	0.39	261	1.18	39.4	0.18	385.9	1.75
FPW-EXC065(E)-L		1930	2280	8W*3	4.66	1280	3.37	75	0.33	232	1.05	32.8	0.15	339.8	1.53
FPW-EXC085(E)-L		2580	3040	8W*3	6.21	1610	4.24	85.5	0.39	296	1.34	43.8	0.2	425.3	1.93
FPW-EXC025(E)-L		3870	4560	8W*5	9.32	2260	5.95	135.5	0.61	445	2.03	66.5	0.3	647	2.94
FPW-EXC050(E)-L		2260	2660	8W*3	5.44	1445	3.8	85.5	0.39	261	1.18	39.4	0.18	385.9	1.75
FPW-EXC2084(E)-L	0-4	2660	3130	12W*3	5.82	1495	3.93	75	0.33	264	1.2	32.8	0.15	371.8	1.68
FPW-EXC2084(E)-L		3540	4170	12W*3	7.76	1900	5	85.5	0.39	345	1.57	43.8	0.2	474.3	2.16
FPW-EXC2024(E)-L		5310	6280	12W*5	11.64	2715	7.14	135.5	0.61	519	2.36	66.5	0.3	721	3.27
FPW-EXC2204(E)-L		3100	3650	12W*3	6.79	1700	4.47	85.5	0.39	305	1.39	39.4	0.18	429.9	1.96
FPW-EXC0863(E)-L	0-4	2480	2920	8W*3	4.05	1280	3.37	75	0.33	232	1.05	32.8	0.15	339.8	1.53
FPW-EXC0883(E)-L		3300	3900	8W*3	5.39	1610	4.24	85.5	0.39	296	1.34	43.8	0.2	425.3	1.93
FPW-EXC0823(E)-L		4950	5840	8W*5	8.10	2260	5.95	135.5	0.61	445	2.03	66.5	0.3	647	2.94
FPW-EXC0864(E)-L	-2-2	2180	2570	12W*3	4.05	1280	3.37	75	0.33	232	1.05	32.8	0.15	339.8	1.53
FPW-EXC0884(E)-L		2900	3420	12W*3	5.39	1610	4.24	85.5	0.39	296	1.34	43.8	0.2	425.3	1.93
FPW-EXC0824(E)-L		4350	5130	12W*5	8.10	2260	5.95	135.5	0.61	445	2.03	66.5	0.3	647	2.94
Fish & Meat Island showcase <Evaporating temperature -10°C>															
CSM-EXC067(E)-L	-2-2	720	820	5W *1	1.65	930	2.45	11	0.075	37.6	0.17	26.7	0.12	75.3	0.365
CSM-EXC087(E)-L		950	1100	5W *2	2.20	1240	3.26	22	0.15	49.4	0.22	34.4	0.16	106.6	0.53
CSM-EXC027(E)-L		1440	1640	5W *3	3.30	1855	4.88	33	0.23	74.1	0.34	53.6	0.24	160.7	0.81
CSM-EXC107M(E)-L		936	1066	5W *1	2.15	930	2.45	11	0.075	75.2	0.34	26.7	0.12	112.9	0.535
CSM-EXC107M(E)-L		1235	1430	5W *2	3.00	1240	3.26	22	0.15	99.2	0.44	34.4	0.16	155.6	0.75
CSM-EXC1027M(E)-L		1872	2132	5W *3	4.60	1855	4.88	33	0.23	148.2	0.68	53.6	0.24	234.8	1.15

Model No.	Temp Range	Req Cooling Capacity		Fan Motor	Display Area (m²)	1-Phase 36V Heating film		1-Phase 220V (50Hz)							
		25°C 60% (W)	27°C 70% (W)			Fan Motor		Light		Anti-dew heater +door frame heater		Total			
						W	A	W	A	W	A	W	A		
Fish & Meat Reach-in showcase <Evaporating temperature -10°C>															
FPW-EXC064PD(E)-L	0-4	1199	1414	12W*3	4.94	205	5.69	63	0.3	62	0.28	98.5	0.45	223.5	1.03
FPW-EXC084PD(E)-L		1595	1881	12W*3	6.59	235	6.5	90	0.4	84	0.48	160.5	0.7	334.5	1.58
FPW-EXC024PD(E)-L		2393	2822	12W*5	9.88	240	6.6	150	0.65	126	0.72	239.8	1.08	515.8	2.45
FPW-EXC040PD(E)-L		1397	1650	12W*3	5.76	233	6.47	63	0.3	68	0.31	110.9	0.51	241.9	1.12

Model No.	Temp Range	Req Cooling Capacity		Fan Motor	Display Area (m²)	3-Phase 380V		1-Phase 220V (50Hz)							
		25°C 60% (W)	27°C 70% (W)			Defrost Heater		Fan Motor		Light		Anti-dew heater +door frame heater		Total	
						W	A	W	A	W	A	W	A	W	A
Fish & Meat Serve over showcase <Evaporating temperature -10°C>															
FAM-BD6(E)	-1-5	850	735	5W*2	1.68	500	1.32	-	-	22	0.15	-	-	163	0.74
FAM-BD8(E)		1130	980	5W*3	2.24	750	1.97	-	-	22	0.15	-	-	250	1.14
FAM-BD2(E)		1695	1470	5W*3	3.36	1065	2.8	-	-	33	0.23	-	-	380	1.73
FAM-BDL1(E)	0-6	505	560	5W*3	1.66	-	-	550	2.5	33	0.23	-	-	166	0.75
FAM-BDL0(E)		1020	1175	5W*3	1.66	-	-	600	2.73	33	0.23	-	-	199	0.9
FAM-BDV1(E)		329	364	5W*2	1.11	-	-	500	2.27	22	0.15	-	-	64	0.29
FAM-BDV0(E)		329	364	5W*2	1.11	-	-	500	2.27	22	0.15	-	-	125	0.57
FAM-BD6N(E)	-1-5	538	596	5W*2	1.46	500	1.32	-	-	22	0.15	-	-	163	0.74
FAM-BD8N(E)		717	795	5W*2	2.1	750	1.97	-	-	22	0.15	-	-	250	1.14
FAM-BD2N(E)		1075	1303	5W*3	2.9	1065	2.8	-	-	33	0.23	-	-	380	1.73
FAM-BD6G(E)-L	-1-5	655	570	5W*2	1.68	500	1.32	-	-	22	0.15	24	0.11	145	0.66
FAM-BD8G(E)-L		870	760	5W*2	2.24	750	1.97	-	-	22	0.15	31	0.14	190	0.87
FAM-BD2G(E)-L		1305	1140	5W*3	3.36	1065	2.8	-	-	33	0.23	46	0.21	293	1.33
FAM-BDLOG(E)-L	0-6	905	790	5W*3	1.66	600	2.73	-	-	87	0.57	108	1.80	18	0.08
FAM-BDL1G(E)-L		444	509	5W*3	1.66	-	-	550	2.5	33	0.23	14	0.06	80	0.36
FAM-BDV0G(E)-L		289	331	5W*2	1.11	-	-	500	2.27	22	0.15	12	0.05	101	0.46
FAM-BDV1G(E)-L		289	331	5W*2	1.11	-	-	500	2.27	22	0.15	9	0.04	54	0.24
FAM-BD6GSD(E)-L	-1-5	575	659	5W*2	1.68	500	1.32	-	-	22	0.15	24	0.11	171	0.78
FAM-BD8GSD(E)-L		756	867	5W*2	2.3	750	1.97	-	-	22	0.15	31	0.14	225	1.03
FAM-BD2GSD(E)-L		1134	1300	5W*3	3.4	1065	2.8	-	-	33	0.23	46	0.21	346	1.57
FAM-BDL0GSD(E)-L	0-6	790	905	5W*3	1.66	-	-	600	2.73	33	0.23	18	0.08	203	0.92
FAM-BDL1GSD(E)-L		444	509	5W*3	1.66	-	-	550	2.5	33	0.23	14	0.06	92	0.42
FAM-BDV0GSD(E)-L		289	331	5W*2	1.08	-	-	500	2.27	22	0.15	12	0.05	123	0.56
FAM-BD6GSDN(E)-L	-1-5	471	540	5W*2	1.4	500	1.32	-	-	22	0.15	24	0.11	171	0.78
FAM-BD8GSDN(E)-L		628	720	5W*2	1.9	750	1.97	-	-	22	0.15	31	0.14	225	1.03
FAM-BD2GSDN(E)-L		945	1085	5W*3	2.8	1065	2.8	-	-	33	0.23	46	0.21	346	1.57
FAM-BDL0GSDN(E)-L	0-6	790	905	5W*3	1.66	-	-	600	2.73	33	0.23	18	0.08	207	0.94
FAM-BDV1GSDN(E)-L	-1-5	850	735	5W*2	1.40	500	1.32	-	-	22	0.15	-	-	132	0.6
FAM-IE6(E)		1130	980	5W*2	1.87	750	1.97	-	-	22	0.15	-	-	210	0.95
FAM-IE2(E)	-1-5	1075	1193	5W*3	2.9	1065	2.8	-	-	33	0.23	-	-	387	1.76
FAM-IE10(E)	0-6	1125	1245	5W*2	2.45	750	1.97	-	-	22	0.15	-	-	276	1.25
FAM-IE10G(E)		1075	1193	5W*2	1.2	380	1	-	-	22	0.15	-	-	191	0.87
FAM-IE6G(E)	-1-5	870	760	5W*2	1.40	-	-	-	-	22	0.15	-	-	138	0.63
FAM-IE8G(E)		870	760	5W*2	1.87	-	-	-	-	22	0.15	-	-	175	0.79
FAM-IE2G(E)		1305	1140	5W*3	2.81	-	-	-	-	33	0.23	-	-	261	1.19
FAM-IE10G(E)		735	640	5W*2	1.12	-	-	-	-	22	0.15	-	-	159	0.72

Model No.	Temp Range	Req Cooling Capacity		Fan Motor	Display Area (m²)	3-Phase 380V		1-Phase 220V (50Hz)							
		25°C 60% (W)	27°C 70% (W)			Defrost Heater		Fan Motor		Light		Anti-dew heater +door frame heater		Total	
						W	A	W	A	W	A	W	A	W	A
Dairy & Dairy Multi-deck showcase <Evaporating temperature -10°C>															
CPW-EXC063(E)-L	3-7	1790	2070	12W*3	5.99	-	-	75	0.3						

